

# MVH3200D Series

## High Performance Digital Relative Humidity & Temperature Sensor



### General Description

[Patents protected & patents pending]

MEMS Vision's relative humidity (RH) and temperature (T) sensors are built by combining the company's revolutionary MoSiC<sup>®</sup> technology with its extensive ASIC design experience. This combination enables high levels of performance, such as fast RH measurement response time and high accuracy.

The technology also offers a very robust proprietary sensor-level protection, ensuring excellent stability against aging and harsh environmental conditions such as shock and volatile chemicals.

The highly miniaturized smart sensors are fully calibrated and provide standard digital I<sup>2</sup>C outputs to enable plug-and-play integration. The output RH & T resolutions can be independently programmed for maximum flexibility and to minimize power consumption, depending on the application and operating conditions.

The micro-Watt levels of power consumption of these sensors make them the ideal choice for portable and remote applications.

MEMS Vision's combined RH/T sensors offer the industry's most competitive performance-to-price value, for a wide range of applications and end users.

### Features

Fast RH response time  
 - Typical 4 seconds time constant

High accuracy  
 - Relative humidity (MVH3201D):  
 ±1.5% RH typ. (10 – 90%RH, 25°C)  
 - Temperature (MVH3201D):  
 ±0.2°C typ.

Independent resolution settings for RH and T  
 - 8, 10, 12 or 14 bits

Fully compliant I<sup>2</sup>C interface

Extended supply voltage range of 1.8V – 5.5V

Very low power consumption  
 - 1.0 µA avg. current at one RH + T meas.  
 per second (8-bit res., 1.8V supply)

Small form factor for use in compact systems  
 - 3 × 2.4 × 0.8 mm DFN-style LGA package

### User Benefits

- **Long Term Stability and Reliability:** Proprietary sensing structures and protection technology, robust biasing circuitry, and self-diagnosis algorithms ensure accurate and repeatable measurements.
- **Digital Output:** Allows for native interfacing with embedded system components such as FPGAs or off-the-shelf microcontrollers.
- **Fully Calibrated System:** Built-in digital sensor calibration ensures high accuracy measurements and linear behavior under varying sensing environments.

### Applications

The MVH3200D series is ideal for use in environmental sensing for consumer electronics, automotive, industrial, agricultural, and other sectors. Some application examples include:

OEM products	Battery-powered systems	Smart phones and tablets
Instrumentation	Drying	HVAC systems
Medical equipment	Meteorology	Building automation
White goods	Refrigeration equipment	Data logging

**Table of Contents**

1. Pin Configuration.....4

2. Pin Assignment and Connection Diagram .....4

3. Functional Description.....4

4. Chip Performance Summary.....5

5. Sleep Current.....7

6. Relative Humidity and Temperature Sensor Performance.....8

    6.1 Accuracy Tolerances.....8

    6.2 Normal Operating Conditions.....9

7. Sensor Interface.....10

    7.1 Sensor Communications.....10

    7.2 Performing Measurements with the MVH3200D Series.....11

    7.3 Accessing the Sensor Non-volatile Memory.....12

        7.3.1 Setting the Measurement Resolution.....13

        7.3.2 Reading the Sensor ID Number.....14

    7.4 I<sup>2</sup>C Timing Specifications .....14

8. Package and PCB Information .....14

    8.1 Package Drawing.....14

    8.2 Tape and Reel Information.....15

    8.3 Soldering Information.....16

    8.4 PCB Layout Considerations.....16

9. Storage and Handling Information.....17

10. Part Numbers.....18

**List of Tables**

Table 1: Pin assignment.....4

Table 2: MVH3200D Series Specifications.....5

Table 3: RH+T measurement times (including wake-up time) at different resolution settings.....12

Table 4: Non-volatile memory registers.....12

Table 5: Register values for different resolution settings.....13

Table 6: I<sup>2</sup>C timing parameters.....14

**List of Figures**

Fig. 1: Diagram of pin configuration (top view).....4

Fig. 2: DFN-style LGA package.....4

Fig. 3: Connection diagram.....4

Fig. 4: MVH3200D series functional diagram.....4

Fig. 5: Sleep current variation over temperature (at V<sub>DD</sub> = 3.3V).....7

Fig. 6: Relative humidity and temperature tolerances (RH tolerances given at T<sub>A</sub> = +25°C).....8

Fig. 7: Relative humidity tolerances across temperature.....9

Fig. 8: Diagram of an I<sup>2</sup>C interconnect with one master and three slave devices.....10

Fig. 9: I<sup>2</sup>C bus start and stop conditions.....10

Fig. 10: Typical measurement sequence.....11

Fig. 11: Sequence of commands to enter the programming mode.....12

Fig. 12: Sequence of commands to modify the relative humidity measurement resolution.....13

Fig. 13: I<sup>2</sup>C timing diagram.....14

Fig. 14: LGA package drawing.....15

Fig. 15: LGA package land pattern (top view).....15

Fig. 16: Packaging tape drawing.....16

Fig. 17: Recommended lead-free soldering profile.....16  
Fig. 18: Thermal isolation of sensor using milled PCB openings.....17

## 1. Pin Configuration

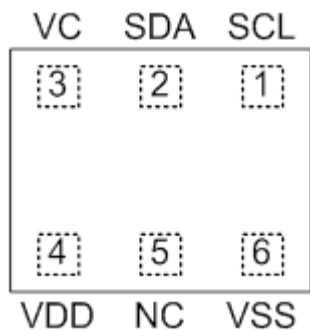

Fig. 1: Diagram of pin configuration (top view).

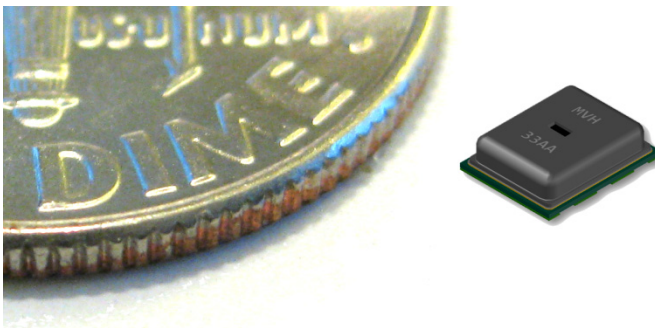

Fig. 2: DFN-style LGA package.

## 2. Pin Assignment and Connection Diagram

Table 1: Pin assignment.

Pin	Name	Function
1	SCL <sup>1</sup>	I <sup>2</sup> C clock (up to 400 kHz)
2	SDA <sup>1</sup>	I <sup>2</sup> C data
3	VC	A 0.1 μF decoupling capacitor
4	VDD	Positive supply
5	NC	No connect
6	VSS	Negative supply or ground

<sup>1</sup>Requires a 2.2 kΩ pull-up resistor.

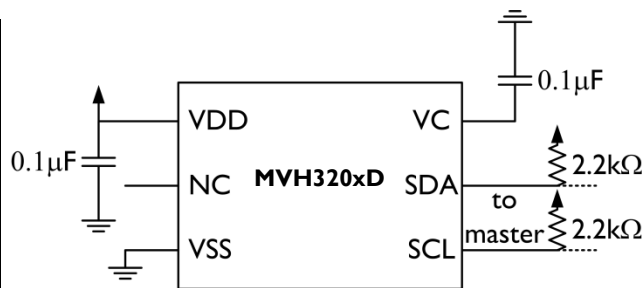

Fig. 3: Connection diagram.

## 3. Functional Description

The MVH3200D series sensors are fully digital devices that accurately measure relative humidity and temperature levels.

An analog-to-digital converter (ADC) with a configurable resolution is interfaced with an analog multiplexer and two sensors in order to allow for the measurement of both relative humidity and temperature. High precision biasing and clock generation ensures stable operation over a wide temperature range. The sensor can be used to

measure the ambient relative humidity and temperature in real-time or be used for data-logging, and can interface with any I<sup>2</sup>C compliant system for digital transmission of the acquired data.

Calibration data and compensation logic are integrated within the system, such that the chip does not require any user calibration, and is readily compensated for accurate operation over a wide range of temperature and humidity levels.

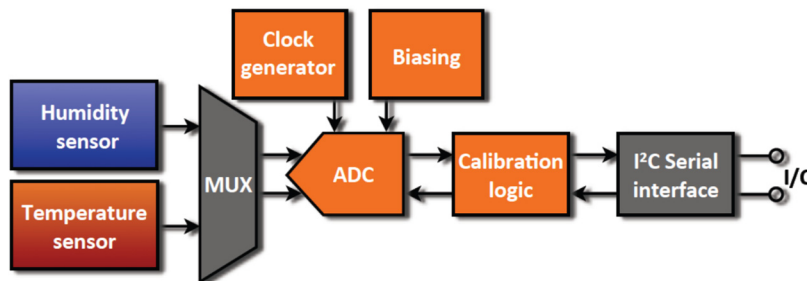

Fig. 4: MVH3200D series functional diagram.

## 4. Chip Performance Summary

Table 2: MVH3200D Series Specifications.  
At  $T_A = +25^\circ\text{C}$ ,  $V_{DD} = +1.8\text{ V}$  to  $+5.5\text{ V}$  unless otherwise noted.

PARAMETER		CONDITION	MIN	TYP	MAX	UNITS
<b>RELATIVE HUMIDITY</b>						
Range			0		100	%RH
Accuracy Tolerance <sup>3</sup>	MVH3201D	10% to 90% RH		$\pm 1.5$	$\pm 1.8$	%RH
	MVH3202D			$\pm 2.0$	$\pm 2.3$	
	MVH3203D	20% to 80% RH		$\pm 2.5$	$\pm 3.5$	
	MVH3204D			$\pm 3.5$	$\pm 4.5$	
Resolution		8 bits		0.7	1.0	%RH
		14 bits		0.01	0.015	
Noise in Humidity (RMS)		14 bits		0.014		%RH
Hysteresis					$\pm 1.0$	%RH
Non-Linearity from Response Curve	MVH3201D	10% to 90% RH		$\pm 0.15$	$\pm 0.25$	%RH
	MVH3202D			$\pm 0.15$	$\pm 0.25$	
	MVH3203D	20% to 80% RH		$\pm 0.15$	$\pm 0.25$	
	MVH3204D			$\pm 0.15$	$\pm 0.25$	
Long-term Stability				0.1	0.25	%RH/yr
Response Time Constant <sup>4</sup> ( $\tau_H$ )		20% to 80% RH Still air	3.0	4.0	6.0	sec.
<b>TEMPERATURE SENSOR</b>						
Range			-40		125	$^\circ\text{C}$
Accuracy Tolerance <sup>5</sup>	MVH3201D	$-10^\circ\text{C}$ to $80^\circ\text{C}$		$\pm 0.2$	$\pm 0.3$	$^\circ\text{C}$
	MVH3202D			$\pm 0.2$	$\pm 0.3$	
	MVH3203D	$0^\circ\text{C}$ to $70^\circ\text{C}$		$\pm 0.25$	$\pm 0.35$	
	MVH3204D			$\pm 0.3$	$\pm 0.5$	
Resolution		8 bits	0.6	0.9	1.5	$^\circ\text{C}$
		14 bits	0.01	0.015	0.025	
Response Time Constant <sup>6</sup> ( $\tau_T$ )				> 2		sec.
Long-term Stability					0.02	$^\circ\text{C}/\text{yr}$
Supply Voltage Dependency <sup>7</sup>		$V_{DD} > 2.8\text{ V}$		0.03	0.1	$^\circ\text{C}/\text{V}$
		$1.8\text{ V} < V_{DD} < 2.8\text{ V}$		1.25	2.25	

Table 2 (cont'd): MVH3200D Series Specifications

PARAMETER		CONDITION	MIN	TYP	MAX	UNITS
<b>CHIP TEMPERATURE RANGE</b>						
Operating Range			-40		125	°C
Recommended Storage Range			0		60	°C
Storage Range			-40		150	°C
<b>MEASUREMENT TIME</b>						
Wake-up Time				0.10		ms
8 bits Resolution		Temp. or Humidity Including digital compensation		0.55		
10 bits Resolution				1.31		
12 bits Resolution				4.50		
14 bits Resolution				16.90		
<b>SLEEP MODE</b>						
Sleep Current <sup>8</sup>	$I_{SD}$	Chip inactive (-40 to 85°C)		0.6		μA
<b>POWER SUPPLY</b>						
Operating Supply Voltage	$V_{DD}$		1.8	3.3	5.5	V
Average Current <sup>9</sup>	$I_Q$	8 bits resolution one RH + T meas./s	1.0	1.5	1.7	μA
		10 bits resolution one RH + T meas./s	2.0	2.6	2.8	
		12 bits resolution one RH + T meas./s	5.5	7.0	7.1	
		14 bits resolution one RH + T meas./s	20.1	24.4	24.4	

<sup>3</sup>For monotonic increases in the range of 10% to 90% RH, after the sensor has been stabilized at 50% RH. See Fig. 6 and Fig. 7 for more details.

<sup>4</sup>From initial value to 63% of total variation.

<sup>5</sup>See Fig. 6 for more details.

<sup>6</sup>Response time depends on system thermal mass (e.g., PCB dimensions and thickness) and air flow.

<sup>7</sup>Sensor accuracy can be optimized for application-specific supply voltages upon request.

<sup>8</sup>See Fig. 5 for more details.

<sup>9</sup>Minimum, typical, and maximum average currents are given at a 1.8V, 3.3V, and 5.5V  $V_{DD}$ , respectively.

## 5. Sleep Current

The sleep current of the MVH3200D series sensors depends on the operating temperature, as shown in Fig. 5. Note that there is no significant dependence of the sleep current on the supply voltage,  $V_{DD}$ .

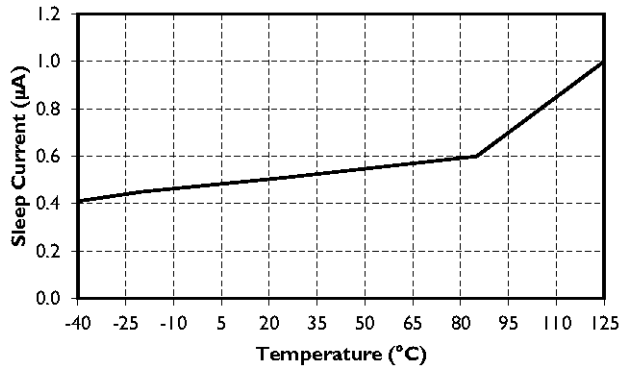

Fig. 5: Sleep current variation over temperature (at  $V_{DD} = 3.3V$ ).

## 6. Relative Humidity and Temperature Sensor Performance

### 6.1 Accuracy Tolerances

The typical and maximum relative humidity and temperature accuracy tolerances for the MVH3200D series sensors are shown in Fig. 6.

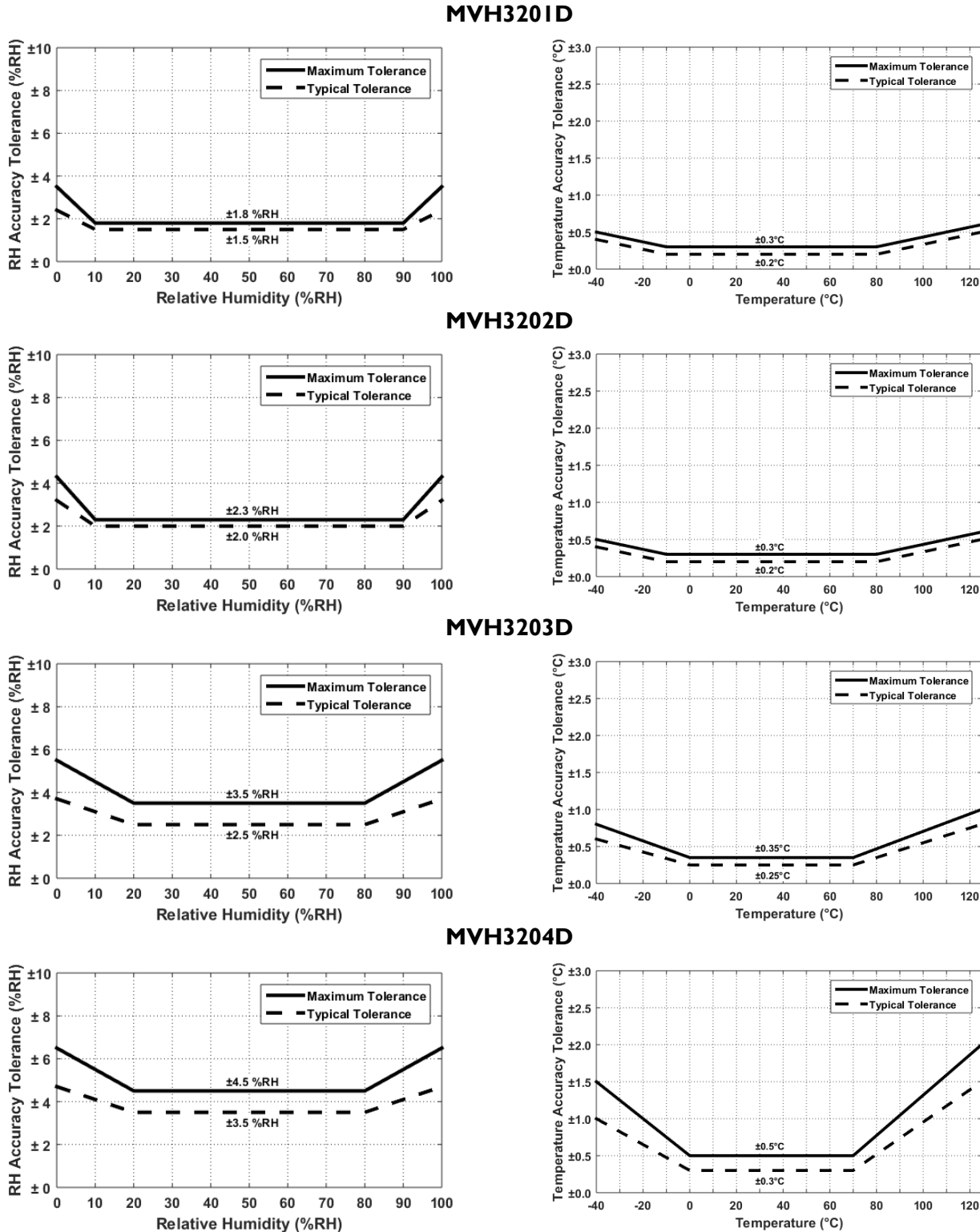

Fig. 6: Relative humidity and temperature tolerances (RH tolerances given at  $T_A = +25^\circ\text{C}$ ).



The typical relative humidity accuracy across temperature is shown in Fig. 7.

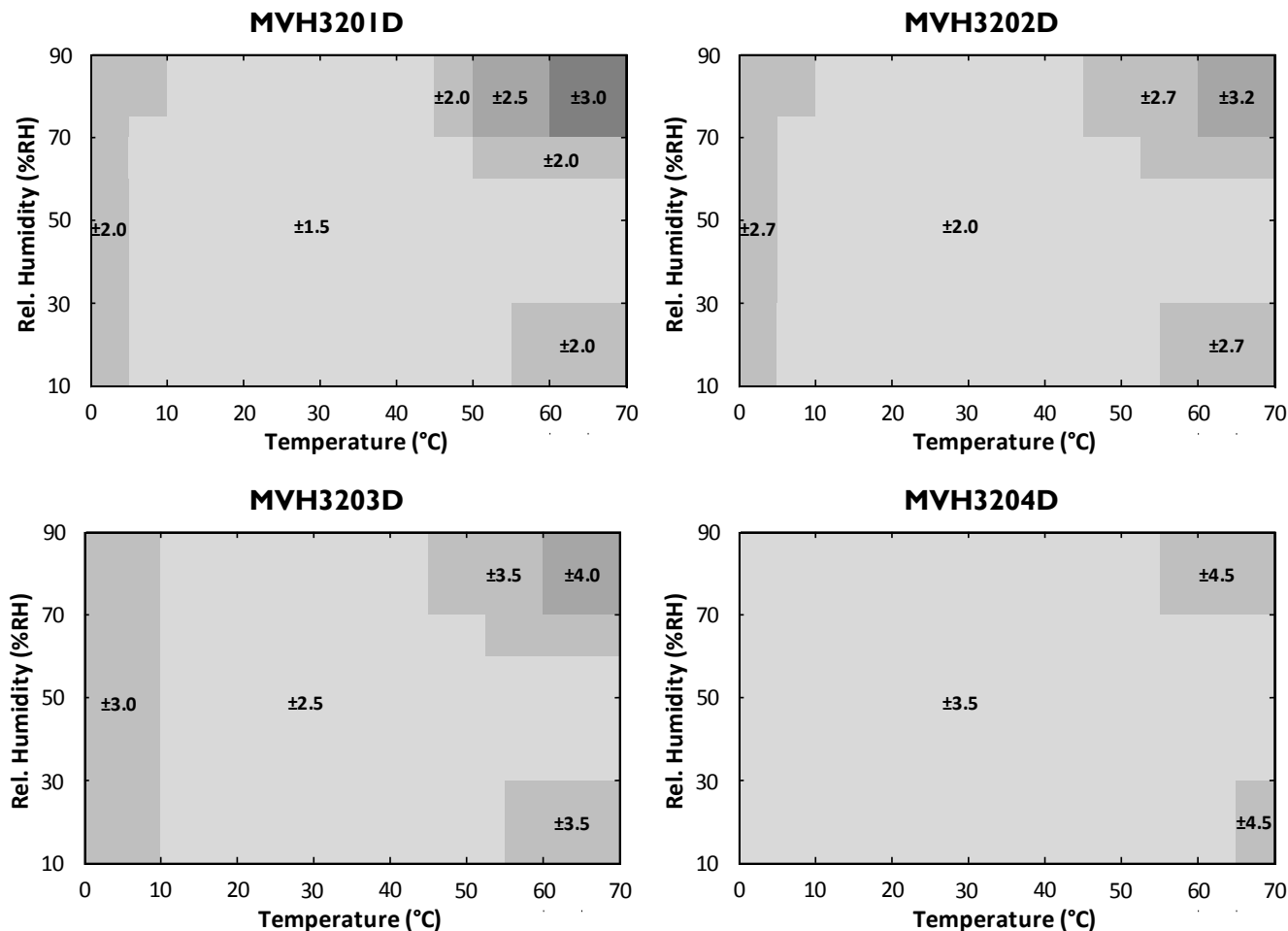

Fig. 7: Relative humidity tolerances across temperature.

## 6.2 Normal Operating Conditions

The sensor has been optimized to perform best in the more common temperature and humidity ranges of 10°C to 50°C and 20% RH to 80% RH (non-condensing), respectively. If operated outside of these conditions for extended periods of time, especially at high humidity levels, the sensors may exhibit an offset. In most cases, this offset is temporary and will gradually disappear once the sensor is returned to normal temperature and humidity conditions. The amount of the shift and the duration of the offset vary depending on the duration of exposure and the severity of the relative humidity and temperature conditions. The time needed for the offset to disappear can also be decreased by using the procedure described in Section 9 of this datasheet.

## 7. Sensor Interface

### 7.1 Sensor Communications

The MVH3200D series sensors communicate using the Inter-IC (I<sup>2</sup>C) standard bus protocol. To accommodate multiple devices, the protocol uses two bi-directional open-drain lines: a Serial Data Line (SDA) and a Serial Clock Line (SCL). Because these are open-drain lines, pull-up resistors to VDD must be provided as shown in Fig. 8. Several slave devices can share the I<sup>2</sup>C bus, but only one master device can be present on the line.

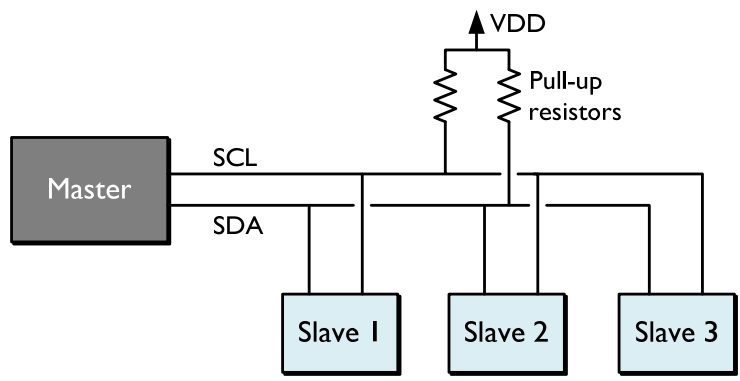

Fig. 8: Diagram of an I<sup>2</sup>C interconnect with one master and three slave devices.

Each transmission is initiated when the master sends a ‘0’ start bit (S), and the transmission is terminated when the master sends a ‘1’ stop bit (P). **These bits are exclusively transmitted while the SCL line is high.** The waveforms corresponding to these conditions are illustrated in Fig. 9.

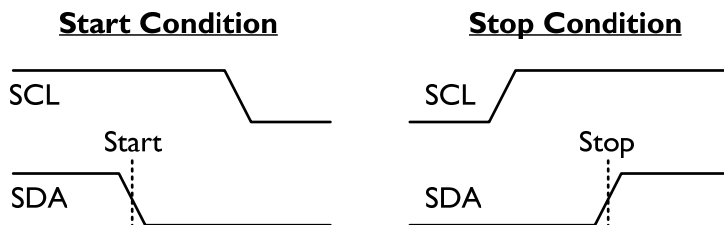

Fig. 9: I<sup>2</sup>C bus start and stop conditions.

Once the start condition has been sent, the SCL line is toggled at the prescribed data-rate, clocking subsequent data transfers. Data on the SDA line is always sampled on the rising edge of the SCL line and must remain stable while SCL is high to prevent false Start or Stop conditions (see Fig. 9).

Following the start bit, address bits select the device targeted for communications and a read/write bit indicates the transfer direction of any subsequent data. The master sends the unique 7-bit address of the desired device and a read/write bit set to ‘1’ to indicate a read from slave to master, or to ‘0’ to indicate a write from master to slave. All transfers consist of eight data bits and one response bit set to ‘0’ for Acknowledge (ACK) or ‘1’ for Not Acknowledge (NACK). After the acknowledge signal is received another data byte can be transferred, or the communication can be stopped with a stop bit.

An MVH3200D series sensor operates as a slave on the I<sup>2</sup>C bus, and supports data rates of up to 400 kHz in accordance with the I<sup>2</sup>C protocol. The default address of the sensor is 0x44. Custom I<sup>2</sup>C addresses can be provided upon request (please contact [support@mems-vision.com](mailto:support@mems-vision.com) for details). The sensor can be interfaced with any I<sup>2</sup>C master such as a microcontroller, and the master is responsible for generating the SCL signal for all communications with the MVH3200D series sensor.

The official I<sup>2</sup>C-bus specification and user manual documentation can be found at:  
[http://www.nxp.com/documents/user\\_manual/UM10204.pdf](http://www.nxp.com/documents/user_manual/UM10204.pdf).

## 7.2 Performing Measurements with the MVH3200D Series

A measurement sequence consists of two steps, as illustrated in Fig. 10:

1. Wake up the MVH3200D series sensor from its sleep mode and initiate a measurement sequence by sending its I<sup>2</sup>C address and a write bit.
2. Once the relative humidity and temperature measurements are completed by the MVH3200D series chip, read the results by sending the I<sup>2</sup>C address of the sensor and a read bit. The sensor will then transmit the relative humidity and temperature data (if requested) on the bus for the master to capture.

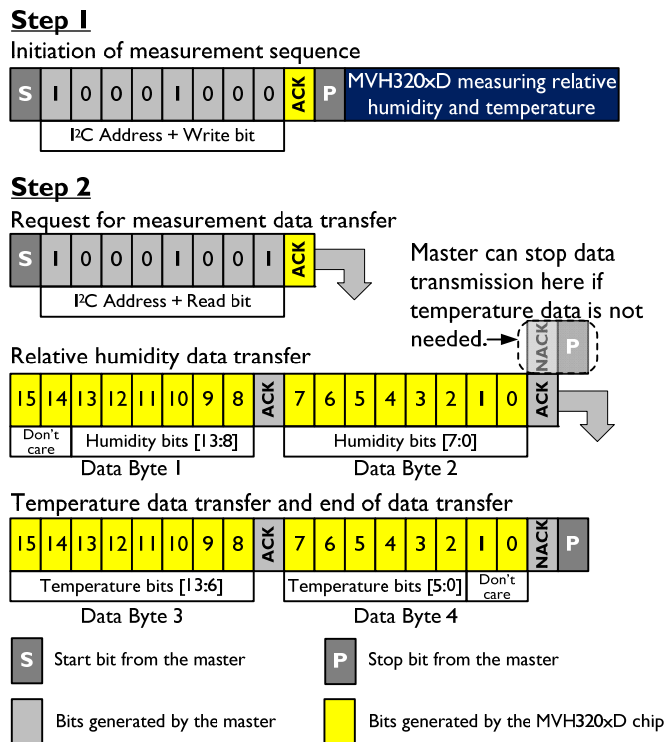

Fig. 10: Typical measurement sequence.

The entire output from the sensor is 4 bytes. The most significant bits of the relative humidity sensor output come out first, followed by the least significant bits. This is followed by the most and least significant bits of the temperature sensor output. The first two and last two bits (“don’t care” bits) do not contain measurement data and should be discarded. As such, the humidity and temperature measurements are always scaled to 14-bits regardless of the selected resolution of the sensor. The relative humidity (in percent) and the temperature (in degrees Celsius) are obtained as follows:

$$\text{Humidity } [\%RH] = \frac{\text{Humidity}[13:0]}{2^{14} - 1} \times 100 \qquad \text{Temperature } [^{\circ}C] = \frac{\text{Temperature}[13:0]}{2^{14} - 1} \times 165 - 40$$

In the event that temperature data is not needed by the user, the read can be terminated by issuing a NACK after the 2<sup>nd</sup> byte. Alternatively, if only 8-bit resolution is desired for the temperature output, the read can be terminated after the 3<sup>rd</sup> byte by issuing a NACK followed by a stop bit. The measurement time depends on the configured sensor resolution. Table 3 lists examples when the resolutions for the relative humidity and temperature measurements are the same. For different relative humidity and

temperature resolution settings, the measurement times in Table 2 should be used, along with the 0.1 ms wake-up time. For example, an 8-bit relative humidity measurement and a 12-bit temperature measurement results in a total measurement time of:

$$0.1 \text{ ms} + 0.55 \text{ ms} + 4.5 \text{ ms} = 5.15 \text{ ms.}$$

Table 3: RH+T measurement times (including wake-up time) at different resolution settings.

Resolution <sup>9</sup> (bits)	Measurement time (ms)
8	1.20
10	2.72
12	9.10
14	33.90

<sup>9</sup>Same resolutions are assumed for both relative humidity and temperature.

### 7.3 Accessing the Sensor Non-volatile Memory

The MVH3200D series non-volatile memory stores its measurement resolution setting and its ID number. To change the sensor resolution or read the ID number, the master must place the MVH3200D series chip into programming mode while the chip is powering up. Figure 11 shows the sequence of commands needed to enter the programming mode, which must be sent within 10 ms after applying power to the sensor. The master must send the I<sup>2</sup>C address and a Write bit followed by the command 0xA0|0x00|0x00.

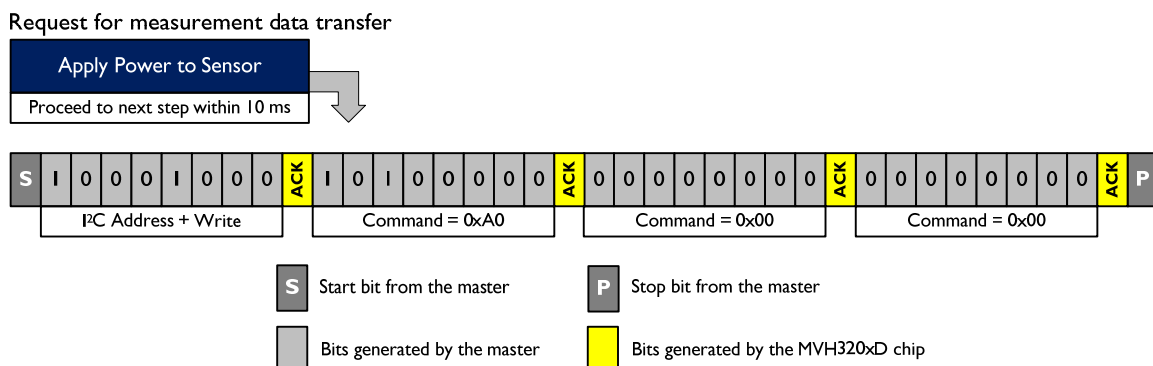

Fig. 11: Sequence of commands to enter the programming mode.

This command takes 120 μs to process, after which the master has access to the non-volatile memory registers listed in Table 4. All of these registers are 16 bits wide.

To return to normal sensor operation and perform measurements, the master must send the I<sup>2</sup>C address and a Write bit, followed by the command: 0x80|0x00|0x00.

Table 4: Non-volatile memory registers.

Address	Register Description
0x06	Humidity Sensor Resolution – Read Register (bits [11:10])
0x46	Humidity Sensor Resolution – Write Register (bits [11:10])
0x11	Temperature Sensor Resolution – Read Register (bits [11:10])
0x51	Temperature Sensor Resolution – Write Register (bits [11:10])
0x1E	Read Sensor ID – Upper 2 bytes
0x1F	Read Sensor ID – Lower 2 bytes

### 7.3.1 Setting the Measurement Resolution

The MVH3200D series relative humidity and temperature measurement resolutions can be set **independently** to 8, 10, 12, or 14 bits by writing to the non-volatile memory, and are initially set to 14 bits by default. The procedure to set the humidity sensor resolution is illustrated in Fig. 12. The relative humidity and temperature resolution can be read in registers 0x06 and 0x11, respectively, or written in registers 0x46 or 0x51. The resolution information is stored in bits [11:10] of these registers, as listed in Table 5. All of the other bits in these registers must be left unchanged. As such, before writing new resolution settings, the contents of the read registers must be read, and only bits [11:10] can be changed in the write registers. Once bits [11:10] are changed to set the desired resolution, the entire register must be written back to the MVH3200D series chip.

#### Step 1

Write the register address

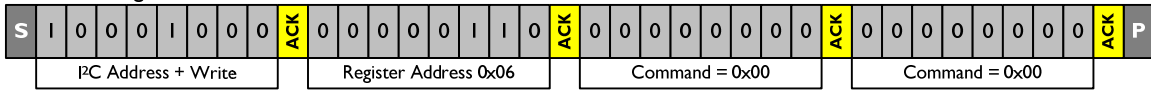

#### Step 2

Read the register contents

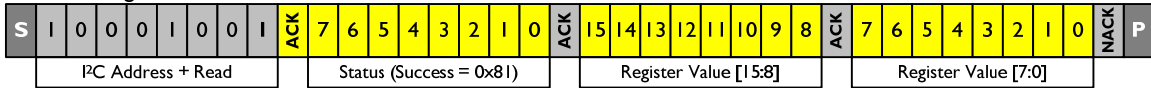

#### Step 3

Change bits [11:10] of the register to the desired resolution setting, **without changing the other bits**

#### Step 4

Write the register contents back

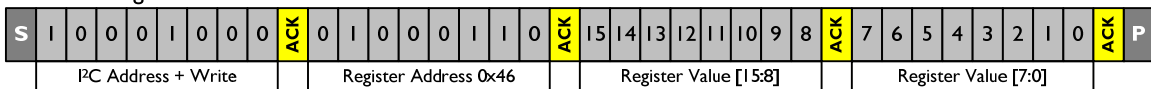

Fig. 12: Sequence of commands to modify the relative humidity measurement resolution.

Table 5: Register values for different resolution settings.

Resolution register bits [11:10]	Resolution (bits)
00 <sub>B</sub>	8
01 <sub>B</sub>	10
10 <sub>B</sub>	12
11 <sub>B</sub>	14

The sensor non-volatile memory requires 120 μs to load the data into the registers after step 1, and requires 14 ms to write the data after step 4. *Failure to comply with these processing times may result in data corruption and introduce errors in sensor measurements.* The procedure to change the temperature sensor

resolution is the same as that depicted in Fig. 12, except the register address in Step 1 must be set to 0x11 and the register address in Step 4 will be 0x51.

### 7.3.2 Reading the Sensor ID Number

The sensor ID is a 32-bit number, and can be read in a similar fashion as illustrated in steps 1 and 2 of Fig. 12, using the appropriate register address values. The ID number is stored in two registers, with the upper and lower 16 bits stored in register addresses 0x1E and 0x1F, respectively.

## 7.4 I<sup>2</sup>C Timing Specifications

The timing diagram for all I<sup>2</sup>C communications is shown in Fig. 13, and the minimum and maximum values for each critical timing parameter (e.g., setup times, hold times) are listed in Table 6.

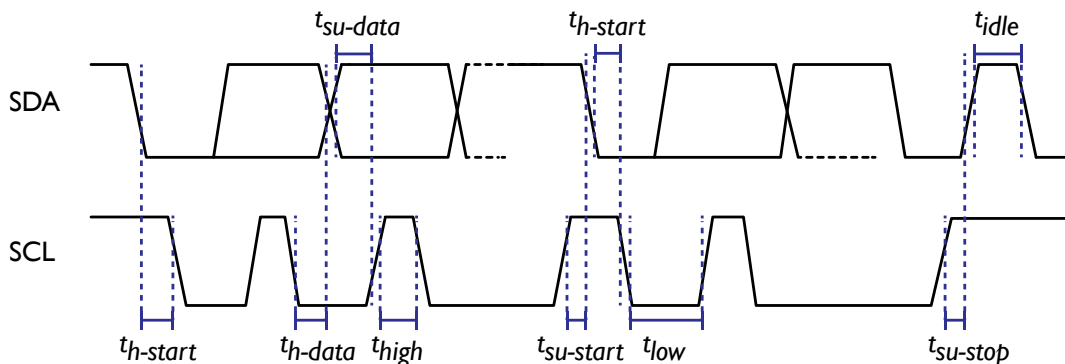

Fig. 13: I<sup>2</sup>C timing diagram.

Table 6: I<sup>2</sup>C timing parameters.

Parameter	Symbol	Min	Max	Units
SCL frequency	$f_{SCL}$	20		kHz
Start bit setup time	$t_{su-start}$	0.1		$\mu$ s
Start bit hold time	$t_{h-start}$	0.1		$\mu$ s
Minimum SCL low/high widths	$t_{low}   t_{high}$	0.6		$\mu$ s
Data setup time	$t_{su-data}$	0.1		$\mu$ s
Data hold time	$t_{h-data}$	0	0.5	$\mu$ s
Stop bit setup time	$t_{su-stop}$	0.1		$\mu$ s
SDA unused time between stop and start bit	$t_{idle}$	1		$\mu$ s

## 8. Package and PCB Information

The MVH3200D series sensors are packaged in a 3 × 2.41 × 0.8 mm 6-pin dual-flat no-leads (DFN)-style LGA package.

### 8.1 Package Drawing

The mechanical drawing of the LGA package is shown in Fig. 14, and a suitable land pattern for soldering the sensor to a PCB is shown in Fig. 15. The units used for all dimensions are mm.

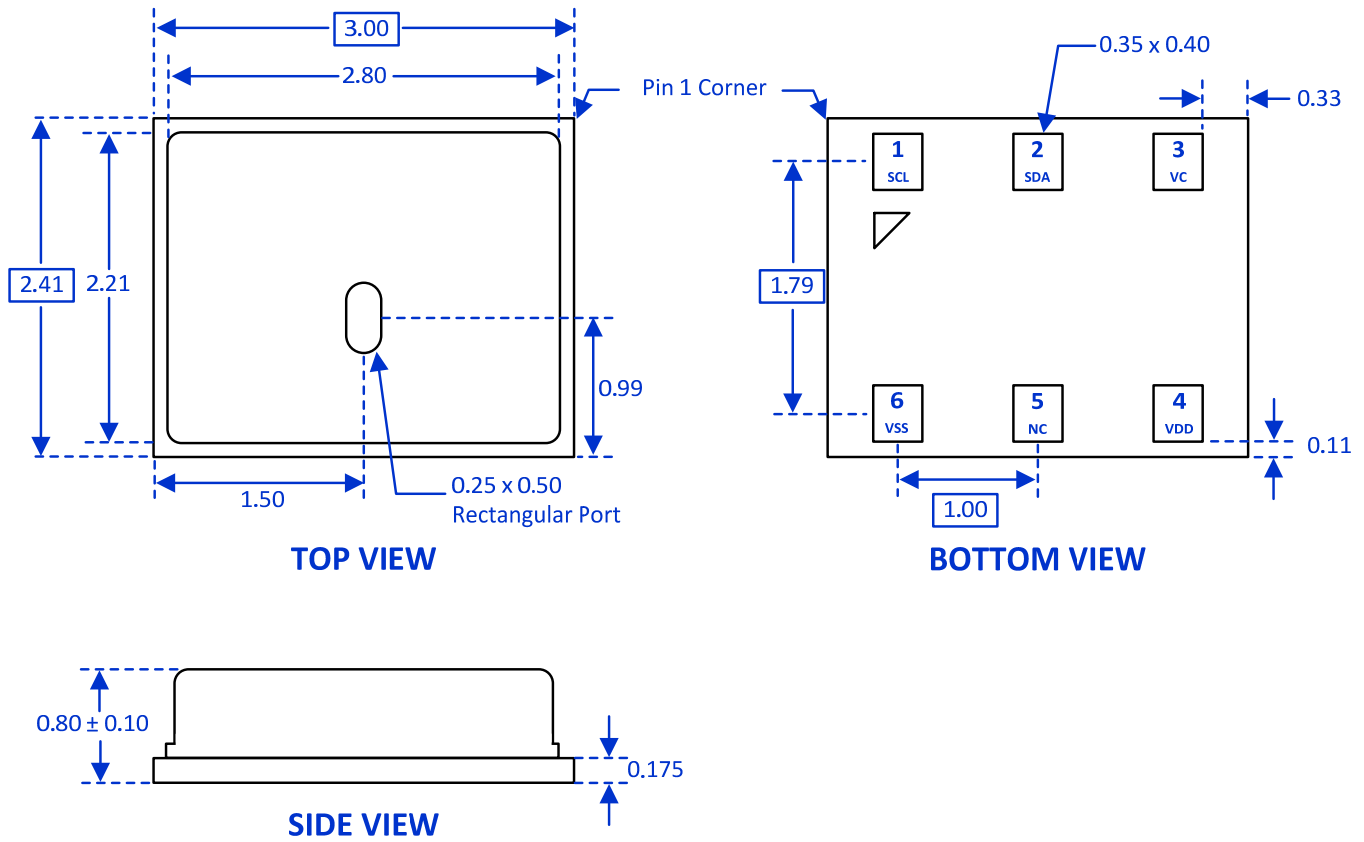

Fig. 14: LGA package drawing.

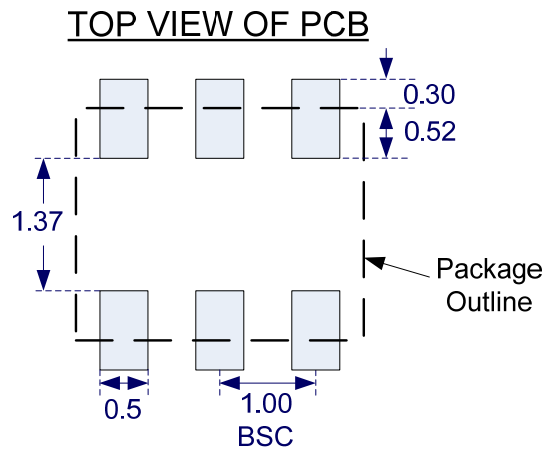

Fig. 15: LGA package land pattern (top view).

## 8.2 Tape and Reel Information

The MVH3200D series sensors are shipped in tape and reel packaging and enclosed in sealed anti-static bags. Standard packaging sizes are 400, 1500, and 2500 units (please contact MEMS Vision for other volumes). The tape has a 470mm leader (117 pockets) and a 410mm trailer (103 pockets). A drawing of the packaging tape is shown in Fig. 16, which also shows the sensor orientation.

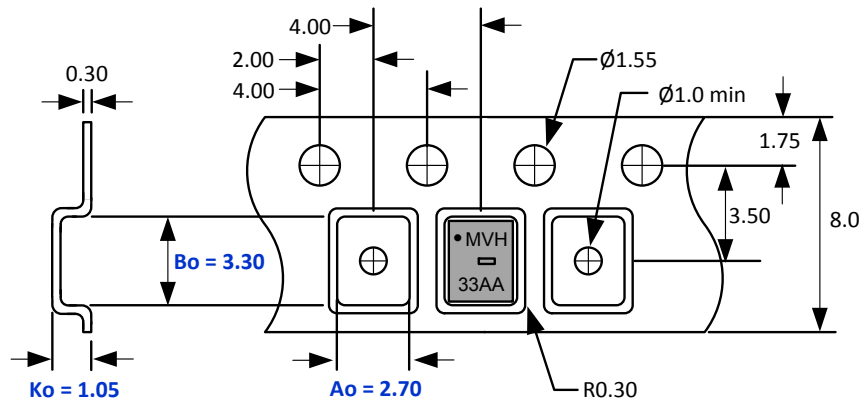

Fig. 16: Packaging tape drawing.

### 8.3 Soldering Information

Standard reflow ovens can be used to solder the MVH3200D series sensor to the PCB. The peak temperature ( $T_p$ ) for use with the JEDEC J-STD-020D standard soldering profile is 260°C. For manual soldering, the contact time must be limited to 5 seconds at up to 350°C. In either case, if solder paste is used, it is recommended to use ‘no-clean’ solder paste to avoid the need to wash the PCB.

Note that reflow soldering is recommended for optimal performance. The recommended lead-free (RoHS compliant) reflow soldering profile is shown in Fig. 17.

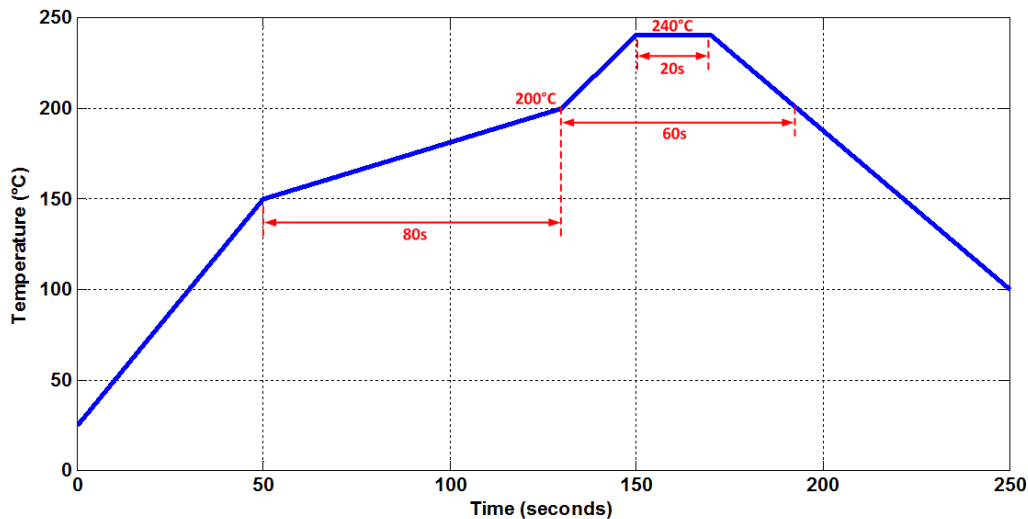

Fig. 17: Recommended lead-free soldering profile

After soldering, the humidity sensor element should be exposed to a humidity of 75% RH for at least 12 hours in order to rehydrate the element. Otherwise, there may be an initial offset in the relative humidity readings, which will slowly disappear as the sensor gets exposed to ambient conditions.

### 8.4 PCB Layout Considerations

When designing the PCB, undesired heat transfer paths to the MVH3200D series chip must be minimized. Excessive heat from other components on the PCB will result in inaccurate temperature and relative humidity measurements. As such, **solid metal planes for power supplies should be avoided in the**



**vicinity of the sensor** since these will act as thermal conductors. To further reduce the heat transfer from other components on the board, openings can be milled into the PCB as shown in Fig. 18.

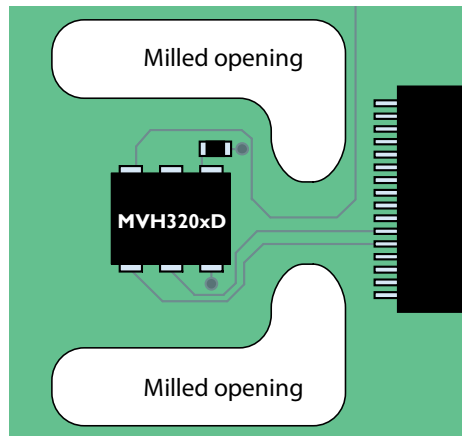

Fig. 18: Thermal isolation of sensor using milled PCB openings.

## 9. Storage and Handling Information

Once the sensors are removed from their original packaging, it is recommended to store them in metal-in antistatic bags. Polyethylene antistatic bags (light blue or pink in color) should be avoided as they may affect sensor accuracy.

The nominal storage conditions for the MVH3200D series chip are at temperatures in the range of 10 to 50°C and at humidity levels within the range of 20% to 60% RH. If the chip is stored outside of these ranges for extended periods of time, the relative humidity sensor readings may exhibit an offset. The sensor can be brought back to its calibration state by applying the following reconditioning procedure:

1. Baking at a temperature of 100°C with a humidity < 10% for 10 -12 hours.
2. Rehydrating the sensor at a humidity of 75% RH and a temperature between 20 to 30°C for 12 to 14 hours.

Note that the sensor may also return to its calibrated state if left at ambient conditions for a longer period of time.

**10. Part Numbers**

<b>Evaluation Board</b>	
MVEVB3	MVH3200D series evaluation board and USB cable
<b>MVH3201D</b>	
MVH3201D	MVH3201D a 3 × 2.4 × 0.8 mm 6-pin DFN-style LGA package
MVH3201D-M	MVH3201D sensor module, for use with the MVEVB3 evaluation board
MVEVB3-K1	Evaluation kit, includes MVEVB3 and MVH3201D-M (x3)
<b>MVH3202D</b>	
MVH3202D	MVH3202D a 3 × 2.41 × 0.8 mm 6-pin DFN-style LGA package
MVH3202D-M	MVH3202D sensor module, for use with the MVEVB3 evaluation board
MVEVB3-K2	Evaluation kit, includes MVEVB3 and MVH3202D-M (x3)
<b>MVH3203D</b>	
MVH3203D	MVH3203D a 3 × 2.41 × 0.8 mm 6-pin DFN-style LGA package
MVH3203D-M	MVH3203D sensor module, for use with the MVEVB3 evaluation board
MVEVB3-K3	Evaluation kit, includes MVEVB3 and MVH3203D-M (x3)
<b>MVH3204D</b>	
MVH3204D	MVH3204D a 3 × 2.41 × 0.8 mm 6-pin DFN-style LGA package
MVH3204D-M	MVH3204D sensor module, for use with the MVEVB3 evaluation board
MVEVB3-K4	Evaluation kit, includes MVEVB3 and MVH3204D-M (x3)

Sold in North America by:  
 Servoflo Corporation  
 75 Allen Street Lexington, MA 02421  
 Tel: 781-862-9572

[www.servoflo.com](http://www.servoflo.com) / [info@servoflo.com](mailto:info@servoflo.com)

© 2018-2020 MEMS Vision Worldwide. All rights reserved.

MEMS Vision, its logo, and MoSiC<sup>®</sup> are trademarks or registered trademarks of MEMS Vision International Inc., Canada, and its subsidiaries in Canada and other countries.

Other trademarks used herein are the property of MEMS Vision or their respective third party owners.

The information in this document is believed to be accurate in all respects at the time of publication, but shall not be regarded as a guarantee of conditions or characteristics. MEMS Vision assumes no responsibility for errors and omissions, and disclaims responsibility for any consequences resulting from the use of information included in this document. MEMS Vision also assumes no responsibility for the functioning of features or parameters not explicitly described herein. MEMS Vision reserves the right to make changes without further notice. MEMS Vision makes no warranty, representation, or guarantee regarding the suitability of its products for any particular purpose, nor does MEMS Vision assume any liability arising out of the application or use of any product or circuit and, specifically DISCLAIMS ANY AND ALL LIABILITY, including without limitation consequential or incidental damages, as well as warranties of non-infringement of intellectual property rights of any third party.

MEMS Vision products are not designed, intended, or authorized for use in applications intended for safety, emergency stopping, or supporting or sustaining life, or for any other application in which the failure of the MEMS Vision product could create a situation where personal injury or death may occur. Should Buyer purchase or use MEMS Vision products for any such unintended or unauthorized application, Buyer shall indemnify and hold MEMS Vision harmless against all claims and damages.

[www.mems-vision.com](http://www.mems-vision.com)

[info@mems-vision.com](mailto:info@mems-vision.com)