

# HCLA Series

## Miniature amplified low pressure sensors

### FEATURES

- 0 ... 2.5 to 0 ... 75 mbar, 0 ...  $\pm 2.5$  to 0 ...  $\pm 75$  mbar, differential or gage
- Output: 0.25...4.25 V and I<sup>2</sup>C-bus (SPI and switching outputs optional)
- Precision ASIC conditioning
- Calibrated and temperature compensated
- Matched pressure port volumes
- Miniature SMT and SIL housings
- RoHS compliant

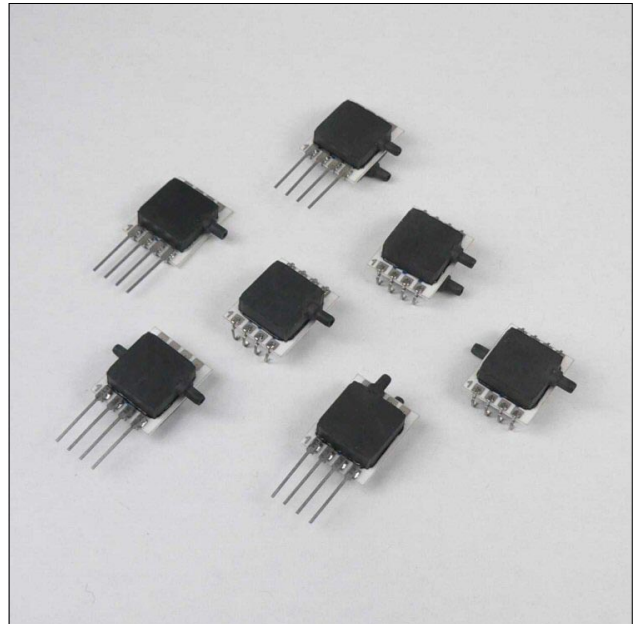

### SPECIFICATIONS

#### Maximum ratings

Supply voltage  $V_s$  4.5 V ... 5.5 V<sub>DC</sub>  
(optional 2.7 ... 3.3 V<sub>DC</sub>)

Output current  
Sink 1 mA  
Source 1 mA

#### Lead specifications

Average preheating temperature gradient 2.5 K/s  
Soak time ca. 3 min  
Time above 217°C 50 s  
Time above 230°C 40 s  
Time above 250°C 15 s  
Peak temperature 260°C  
Cooling temperature gradient -3.5 K/s

#### Temperature ranges

Compensated -25 ... 85°C  
Operating -25 ... 85°C  
Storage -40 ... 125°C

Humidity limits (non-condensing) 0 ... 95 %RH

### ELECTRICAL CONNECTION

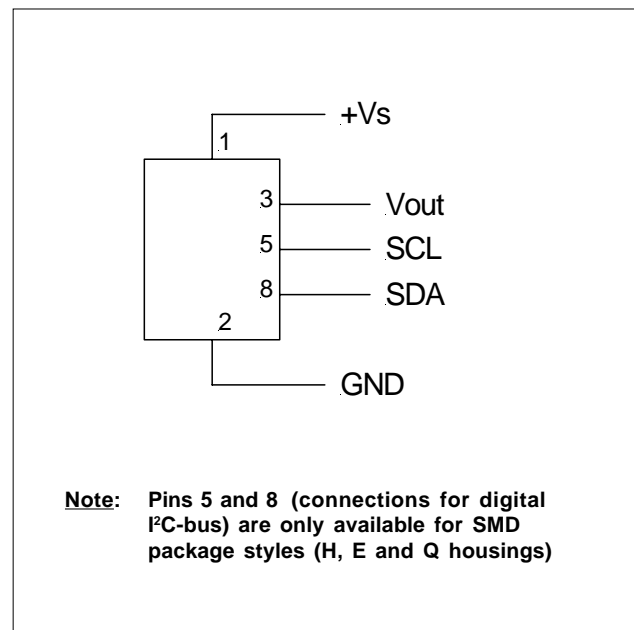

Sold in North America by:  
Servoflo Corporation  
75 Allen Street Lexington, MA 02421  
Tel: 781-862-9572  
[www.servoflo.com](http://www.servoflo.com) / [info@servoflo.com](mailto:info@servoflo.com)

# HCLA Series

## Miniature amplified low pressure sensors

---

### PRESSURE SENSOR CHARACTERISTICS

( $V_s = 5.0\text{ V}$ ,  $T_A = 25\text{ °C}$ , analog output signal is **ratiometric** to  $V_s$ , digital output signal is **not ratiometric** to  $V_s$ , pressure applied to high pressure port)

Part no.	Operating pressure	Proof pressure <sup>5,7</sup>	Burst pressure <sup>6,7</sup>	Output signal
HCLA02X5...B	0...±2.5 mbar	250 mbar	500 mbar	2.25 ±2 V
HCLA12X5...B	0...±12.5 mbar	250 mbar	500 mbar	
HCLA0025...B	0...±25 mbar	500 mbar	750 mbar	
HCLA0050...B	0...±50 mbar	750 mbar	1200 mbar	
HCLA0075...B	0...±75 mbar	1200 mbar	2000 mbar	
HCLA02X5...U	0...2.5 mbar	250 mbar	500 mbar	0.25 - 4.25 V
HCLA12X5...U	0...12.5 mbar	250 mbar	500 mbar	
HCLA0025...U	0...25 mbar	500 mbar	750 mbar	
HCLA0050...U	0...50 mbar	750 mbar	1200 mbar	
HCLA0075...U	0...75 mbar	1200 mbar	2000 mbar	

#### Specification notes:

1. Shift is relative to 25°C.
2. Shift is within the first hour of excitation applied to the device.
3. Non-linearity refers to the **Best Straight Line** fit, measured for lowest specified pressure, highest specified pressure and 1/2 full scale pressure.
4. Full Scale Span (FSS) is the algebraic difference between the output signal for the highest and lowest specified pressure.
5. Proof pressure is the maximum pressure which may be applied without causing durable shifts of the electrical parameters of the sensing element.
6. Burst pressure is the maximum pressure which may be applied without causing damage to the sensing element or leaks to the housing.
7. The common mode pressure for the HCLA series is 2 bar. Common mode pressure is the maximum pressure that can be applied to both ports of a differential pressure sensor simultaneously without damaging the sensor housing.
8. Max. delay time between pressure change at the pressure die and signal change at the output.
9. The response time depends on the adjusted internal A/D resolution of the sensor. For 12 bit it is typ. 0.5 ms. Other A/D resolutions and response times are available on request. Please contact First Sensor for further information.
10. Sensors with lower current consumption are available on request. Please contact First Sensor for further information.

# HCLA Series

## Miniature amplified low pressure sensors

### PERFORMANCE CHARACTERISTICS

( $V_s = 5.0\text{ V}$ ,  $T_A = 25\text{ °C}$ , analog output signal is **ratiometric** to  $V_s$ , digital output signal is **not ratiometric** to  $V_s$ , pressure applied to high pressure port)

#### HCLA02X5...

Characteristics	Min.	Typ.	Max.	Unit
Non-linearity and hysteresis (BSL) <sup>3</sup>		±0.05	±0.25	%FSS
Thermal effects (-25 to 85°C) <sup>1</sup>	Offset		±1.5	
	Span		±2.0	
Response delay <sup>8,9</sup>		0.5		ms
A/D resolution <sup>9</sup>		12		bit
D/A resolution			11	
Current consumption (no load) <sup>10</sup>		5		mA
DIGITAL PERFORMANCE CHARACTERISTICS				
Offset warm-up shift <sup>2</sup>		±0042		Count Hex
Offset position sensitivity (±1 g)		±0063		
Offset long term drift (one year)		±0042		
ANALOGUE PERFORMANCE CHARACTERISTICS				
Offset warm-up shift <sup>2</sup>		±10		mV
Offset position sensitivity (±1 g)		±15		
Offset long term drift (one year)		±10		

#### HCLA02X5...B

Characteristics	Min.	Typ.	Max.	Unit
Operating pressure range	-2.5		+2.5	mbar
DIGITAL PERFORMANCE CHARACTERISTICS				
Zero pressure offset	370A	3999	3C28	Count Hex
Full scale span (FSS) <sup>4</sup>	63D6	6666	68F5	
Output	at +2.5 mbar	6CCC		
	at -2.5 mbar	0666		
ANALOGUE PERFORMANCE CHARACTERISTICS				
Zero pressure offset	2.15	2.25	2.35	V
Full scale span (FSS) <sup>4</sup>	3.90	4.00	4.10	
Output	at +2.5 mbar	4.25		
	at -2.5 mbar	0.25		

#### HCLA02X5...U

Characteristics	Min.	Typ.	Max.	Unit
Operating pressure range	0		+2.5	mbar
DIGITAL PERFORMANCE CHARACTERISTICS				
Zero pressure offset	03D7	0666	08F6	Count Hex
Full scale span (FSS) <sup>4</sup>	63D6	6666	68F5	
Full scale output		6CCC		
ANALOGUE PERFORMANCE CHARACTERISTICS				
Zero pressure offset	0.15	0.25	0.35	V
Full scale span (FSS) <sup>4</sup>	3.90	4.00	4.10	
Full scale output		4.25		

# HCLA Series

## Miniature amplified low pressure sensors

### PERFORMANCE CHARACTERISTICS (cont.)

( $V_s = 5.0\text{ V}$ ,  $T_A = 25\text{ °C}$ , analog output signal is **rationometric** to  $V_s$ , digital output signal is **not ratiometric** to  $V_s$ , pressure applied to high pressure port)

#### HCLA12X5...

Characteristics	Min.	Typ.	Max.	Unit
Non-linearity and hysteresis (BSL) <sup>3</sup>		±0.05	±0.25	%FSS
Thermal effects (-25 to 85°C) <sup>1</sup>	Offset		±1.0	
	Span		±1.0	
Response delay <sup>8,9</sup>		0.5		ms
A/D resolution <sup>9</sup>		12		bit
D/A resolution			11	
Current consumption (no load) <sup>10</sup>		5		mA
DIGITAL PERFORMANCE CHARACTERISTICS				
Offset warm-up shift <sup>2</sup>		±0021		Count Hex
Offset position sensitivity (±1 g)		±0021		
Offset long term drift (one year)		±0021		
ANALOGUE PERFORMANCE CHARACTERISTICS				
Offset warm-up shift <sup>2</sup>		±5		mV
Offset position sensitivity (±1 g)		±5		
Offset long term drift (one year)		±5		

#### HCLA12X5...B

Characteristics	Min.	Typ.	Max.	Unit
Operating pressure range	-12.5		+12.5	mbar
DIGITAL PERFORMANCE CHARACTERISTICS				
Zero pressure offset	370A	3999	3C28	Count Hex
Full scale span (FSS) <sup>4</sup>	63D6	6666	68F5	
Output	at +12.5 mbar	6CCC		
	at -12.5 mbar	0666		
ANALOGUE PERFORMANCE CHARACTERISTICS				
Zero pressure offset	2.15	2.25	2.35	V
Full scale span (FSS) <sup>4</sup>	3.90	4.00	4.10	
Output	at +12.5 mbar	4.25		
	at -12.5 mbar	0.25		

#### HCLA12X5...U

Characteristics	Min.	Typ.	Max.	Unit
Operating pressure range	0		+12.5	mbar
DIGITAL PERFORMANCE CHARACTERISTICS				
Zero pressure offset	03D7	0666	08F6	Count Hex
Full scale span (FSS) <sup>4</sup>	63D6	6666	68F5	
Full scale output		6CCC		
ANALOGUE PERFORMANCE CHARACTERISTICS				
Zero pressure offset	0.15	0.25	0.35	V
Full scale span (FSS) <sup>4</sup>	3.90	4.00	4.10	
Full scale output		4.25		

# HCLA Series

## Miniature amplified low pressure sensors

### PERFORMANCE CHARACTERISTICS (cont.)

( $V_s = 5.0\text{ V}$ ,  $T_A = 25\text{ °C}$ , analog output signal is **rationometric** to  $V_s$ , digital output signal is **not rationometric** to  $V_s$ , pressure applied to high pressure port)

#### HCLA0025...

Characteristics	Min.	Typ.	Max.	Unit
Non-linearity and hysteresis (BSL) <sup>3</sup>		±0.05	±0.25	%FSS
Thermal effects (-25 to 85°C) <sup>1</sup>	Offset		±0.5	
	Span		±1.0	
Response delay <sup>8,9</sup>		0.5		ms
A/D resolution <sup>9</sup>		12		bit
D/A resolution			11	
Current consumption (no load) <sup>10</sup>		5		mA
DIGITAL PERFORMANCE CHARACTERISTICS				
Offset warm-up shift <sup>2</sup>		±0021		Count Hex
Offset position sensitivity (±1 g)		±0021		
Offset long term drift (one year)		±0021		
ANALOGUE PERFORMANCE CHARACTERISTICS				
Offset warm-up shift <sup>2</sup>		±5		mV
Offset position sensitivity (±1 g)		±5		
Offset long term drift (one year)		±5		

#### HCLA0025...B

Characteristics	Min.	Typ.	Max.	Unit
Operating pressure range	-25		+25	mbar
DIGITAL PERFORMANCE CHARACTERISTICS				
Zero pressure offset	370A	3999	3C28	Count Hex
Full scale span (FSS) <sup>4</sup>	63D6	6666	68F5	
Output	at +25 mbar	6CCC		
	at -25 mbar	0666		
ANALOGUE PERFORMANCE CHARACTERISTICS				
Zero pressure offset	2.15	2.25	2.35	V
Full scale span (FSS) <sup>4</sup>	3.90	4.00	4.10	
Output	at +25 mbar	4.25		
	at -25 mbar	0.25		

#### HCLA0025...U

Characteristics	Min.	Typ.	Max.	Unit
Operating pressure range	0		+25	mbar
DIGITAL PERFORMANCE CHARACTERISTICS				
Zero pressure offset	03D7	0666	08F6	Count Hex
Full scale span (FSS) <sup>4</sup>	63D6	6666	68F5	
Full scale output		6CCC		
ANALOGUE PERFORMANCE CHARACTERISTICS				
Zero pressure offset	0.15	0.25	0.35	V
Full scale span (FSS) <sup>4</sup>	3.90	4.00	4.10	
Full scale output		4.25		

# HCLA Series

## Miniature amplified low pressure sensors

### PERFORMANCE CHARACTERISTICS (cont.)

( $V_s = 5.0\text{ V}$ ,  $T_A = 25\text{ °C}$ , analog output signal is **ratiometric** to  $V_s$ , digital output signal is **not ratiometric** to  $V_s$ , pressure applied to high pressure port)

#### HCLA0050...

Characteristics	Min.	Typ.	Max.	Unit
Non-linearity and hysteresis (BSL) <sup>3</sup>		±0.05	±0.25	%FSS
Thermal effects (-25 to 85°C) <sup>1</sup>	Offset		±0.5	
	Span		±1.0	
Response delay <sup>8,9</sup>		0.5		ms
A/D resolution <sup>9</sup>		12		bit
D/A resolution			11	
Current consumption (no load) <sup>10</sup>		5		mA
DIGITAL PERFORMANCE CHARACTERISTICS				
Offset warm-up shift <sup>2</sup>		±0021		Count Hex
Offset position sensitivity (±1 g)		±0021		
Offset long term drift (one year)		±0021		
ANALOGUE PERFORMANCE CHARACTERISTICS				
Offset warm-up shift <sup>2</sup>		±5		mV
Offset position sensitivity (±1 g)		±5		
Offset long term drift (one year)		±5		

#### HCLA0050...B

Characteristics	Min.	Typ.	Max.	Unit
Operating pressure range	-50		+50	mbar
DIGITAL PERFORMANCE CHARACTERISTICS				
Zero pressure offset	370A	3999	3C28	Count Hex
Full scale span (FSS) <sup>4</sup>	63D6	6666	68F5	
Output	at +50 mbar	6CCC		
	at -50 mbar	0666		
ANALOGUE PERFORMANCE CHARACTERISTICS				
Zero pressure offset	2.15	2.25	2.35	V
Full scale span (FSS) <sup>4</sup>	3.90	4.00	4.10	
Output	at +50 mbar	4.25		
	at -50 mbar	0.25		

#### HCLA0050...U

Characteristics	Min.	Typ.	Max.	Unit
Operating pressure range	0		+50	mbar
DIGITAL PERFORMANCE CHARACTERISTICS				
Zero pressure offset	03D7	0666	08F6	Count Hex
Full scale span (FSS) <sup>4</sup>	63D6	6666	68F5	
Full scale output		6CCC		
ANALOGUE PERFORMANCE CHARACTERISTICS				
Zero pressure offset	0.15	0.25	0.35	V
Full scale span (FSS) <sup>4</sup>	3.90	4.00	4.10	
Full scale output		4.25		

# HCLA Series

## Miniature amplified low pressure sensors

### PERFORMANCE CHARACTERISTICS (cont.)

( $V_s = 5.0\text{ V}$ ,  $T_A = 25\text{ °C}$ , analog output signal is **rationometric** to  $V_s$ , digital output signal is **not ratiometric** to  $V_s$ , pressure applied to high pressure port)

#### HCLA0075...

Characteristics	Min.	Typ.	Max.	Unit
Non-linearity and hysteresis (BSL) <sup>3</sup>		±0.05	±0.25	%FSS
Thermal effects (-25 to 85°C) <sup>1</sup>	Offset		±0.5	
	Span		±1.0	
Response delay <sup>8,9</sup>		0.5		ms
A/D resolution <sup>9</sup>		12		bit
D/A resolution			11	
Current consumption (no load) <sup>10</sup>		5		mA
DIGITAL PERFORMANCE CHARACTERISTICS				
Offset warm-up shift <sup>2</sup>		±0021		Count Hex
Offset position sensitivity (±1 g)		±0021		
Offset long term drift (one year)		±0021		
ANALOGUE PERFORMANCE CHARACTERISTICS				
Offset warm-up shift <sup>2</sup>		±5		mV
Offset position sensitivity (±1 g)		±5		
Offset long term drift (one year)		±5		

#### HCLA0075...B

Characteristics	Min.	Typ.	Max.	Unit
Operating pressure range	-75		+75	mbar
DIGITAL PERFORMANCE CHARACTERISTICS				
Zero pressure offset	370A	3999	3C28	Count Hex
Full scale span (FSS) <sup>4</sup>	63D6	6666	68F5	
Output	at +75 mbar	6CCC		
	at -75 mbar	0666		
ANALOGUE PERFORMANCE CHARACTERISTICS				
Zero pressure offset	2.15	2.25	2.35	V
Full scale span (FSS) <sup>4</sup>	3.90	4.00	4.10	
Output	at +75 mbar	4.25		
	at -75 mbar	0.25		

#### HCLA0075...U

Characteristics	Min.	Typ.	Max.	Unit
Operating pressure range	0		+75	mbar
DIGITAL PERFORMANCE CHARACTERISTICS				
Zero pressure offset	03D7	0666	08F6	Count Hex
Full scale span (FSS) <sup>4</sup>	63D6	6666	68F5	
Full scale output		6CCC		
ANALOGUE PERFORMANCE CHARACTERISTICS				
Zero pressure offset	0.15	0.25	0.35	V
Full scale span (FSS) <sup>4</sup>	3.90	4.00	4.10	
Full scale output		4.25		

## I<sup>2</sup>C BUS

### Introduction

The HCLA is capable to generate a digital output signal. The device runs a cyclic program, which will store a corrected pressure value with 12 bit resolution about every 250  $\mu$ s within the output registers of the internal ASIC. In order to use the sensor for digital signal readout, it should be connected to a bidirectional I<sup>2</sup>C-bus.

According to the I<sup>2</sup>C-bus specification, the bus is controlled by a master device, which generates the clock signal, controls the bus access and generates START and STOP conditions. The HCLA is designed to work as a slave, hence it will only respond to requests from a master device.

### Digital I<sup>2</sup>C interface

The HCLA complies with the following protocol (Fig. 1):

**Bus not busy:** During idle periods both data line (SDA) and clock line (SCL) remain HIGH.

**START condition (S):** HIGH to LOW transition of SDA line while clock (SCL) is HIGH is interpreted as START condition. START conditions are always generated by the master. Each initial request for a pressure value has to begin with a START condition.

**STOP condition (P):** LOW to HIGH transition of SDA line while clock (SCL) is HIGH determines STOP condition. STOP conditions are always generated by the master. More than one request for the current pressure value can be transmitted without generation of intermediate STOP condition.

**DATA valid (D):** State of data line represents valid data when, after START condition, data line is stable for duration of HIGH period of clock signal. Data on line must be changed during LOW period of clock signal. There is one clock pulse per bit of data.

**Acknowledge (A):** Data is transferred in pieces of 8 bits (1 byte) on serial bus, MSB first. After each byte receiving device – whether master or slave – is obliged to pull data line LOW as acknowledge for reception of data. Master must generate an extra clock pulse for this purpose. When acknowledge is missed, slave transmitter becomes inactive. It is on master either to send last command again or to generate STOP condition in that case.

**Slave address:** The I<sup>2</sup>C-bus master-slave concept requires a unique address for each device. The HCLA has a preconfigured slave address (1111000xb). By factory programming it is possible to define a secondary slave address additional to the general one. According to I<sup>2</sup>C specification 127 different addresses are available. The sensor will then listen to both slave addresses. After generating a START condition the master sends the address byte containing a 7 bit address followed by a data direction bit (R/W). A "0" indicates a transmission from master to slave (WRITE), a "1" indicates a data request (READ).

**DATA operation:** The sensor starts to send 2 data bytes containing the current pressure value as a 15 bit information placed in the output registers.

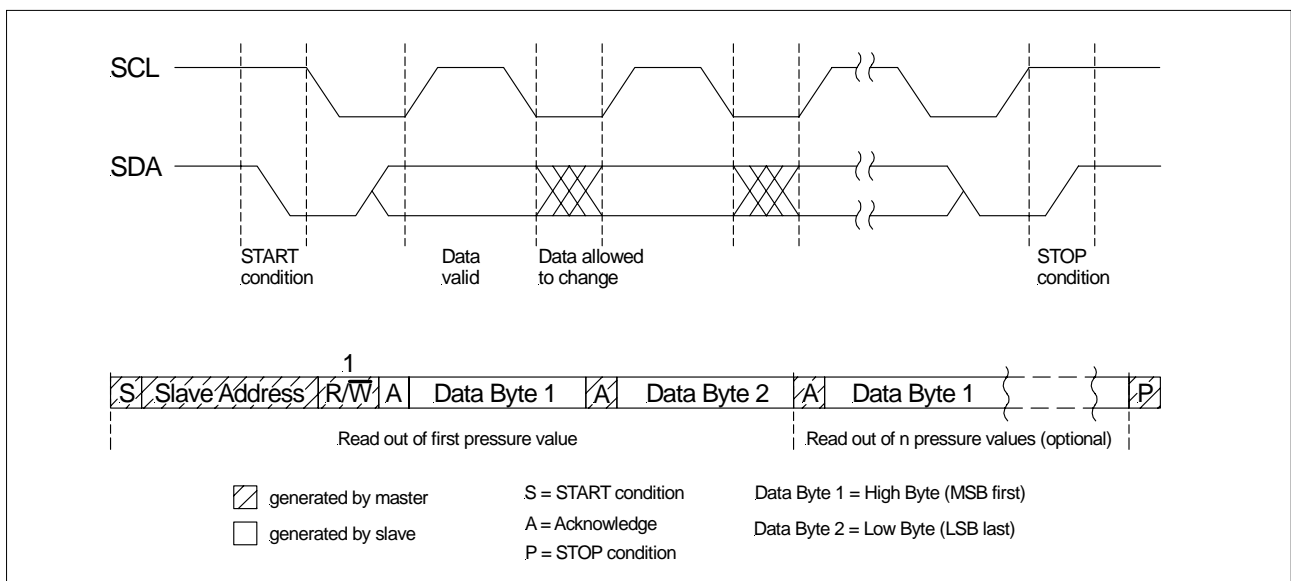

Fig. 1: I<sup>2</sup>C bus protocol



# HCLA Series

## Miniature amplified low pressure sensors

### I<sup>2</sup>C Interface Parameters

Parameter	Symbol	Min.	Typ.	Max.	Unit
Input high level		90		100	% of V <sub>s</sub>
Input low level		0		10	
Output low level				10	
Pull-up resistor		500			Ω
Load capacitance @ SDA	C <sub>SDA</sub>			400	pF
Input capacitance @ SDA/SCL	C <sub>I2C IN</sub>			10	
SCL clock frequency	F <sub>SCL</sub>	100*		400	kHz
Bus free time between STOP and START condition	t <sub>BUF</sub>	1.3			μs
Hold time (repeated) START condition, to first clock pulse	t <sub>HD,STA</sub>	0.8			
LOW period of SCL	t <sub>LOW</sub>	1.3			
HIGH period of SCL	t <sub>HIGH</sub>	0.6			
Setup time repeated START condition	t <sub>SU,STA</sub>	1			
Data hold time	t <sub>HD,DAT</sub>	0			
Data setup time	t <sub>SU,DAT</sub>	0.2			
Rise time of both SDA and SCL	t <sub>R</sub>			0.3	
Fall time of both SDA and SCL	t <sub>F</sub>			0.3	
Setup time for STOP condition	t <sub>SU,STO</sub>	0.6			

\* recommended

**Note:** First Sensor recommends communication speeds of at least 100 kHz (max. 400 kHz). Please contact us for further information.

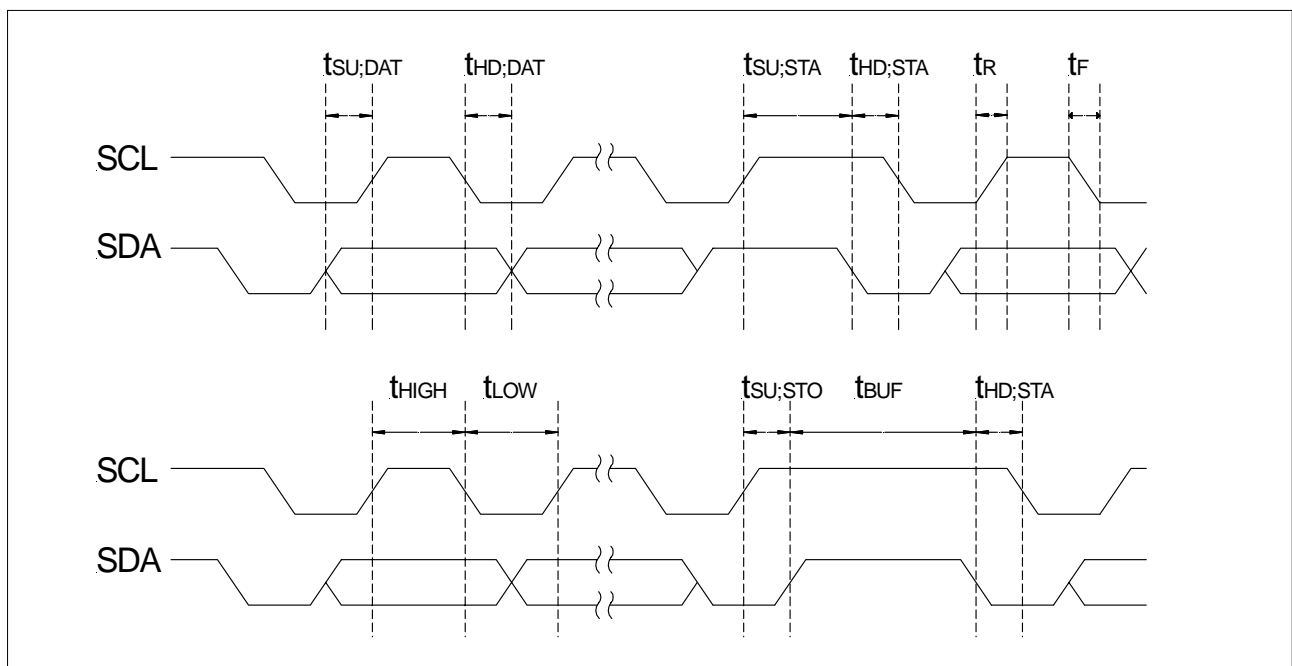

Fig. 2: Timing characteristics

# HCLA Series

## Miniature amplified low pressure sensors

### PHYSICAL DIMENSIONS AND ELECTRICAL CONNECTIONS

HCLA...D...

SIL dual port, same side

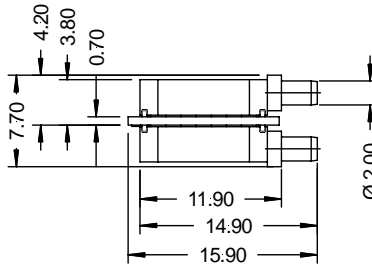
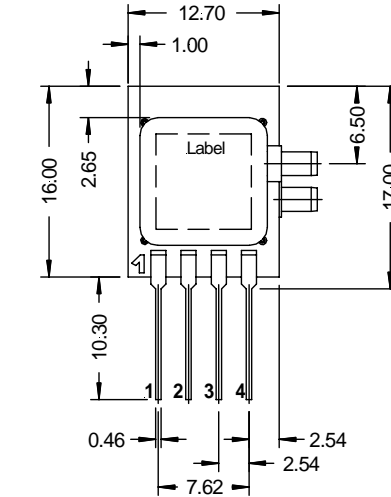
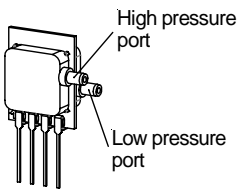
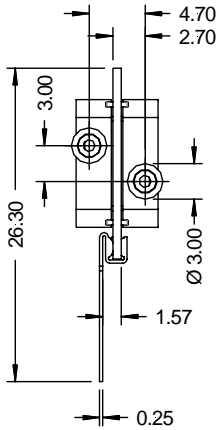

Pin	Connection
1	+Vs
2	GND
3	Vout
4	I / C *

\* Internal connection.  
Do not connect  
for any reason

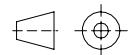

first angle projection  
dimensions in mm

HCLA...E...

SMD dual port, same side

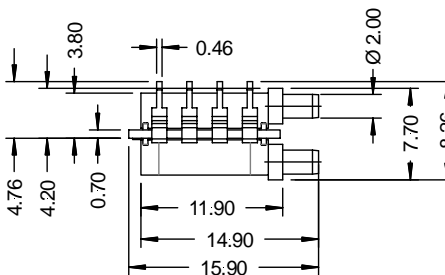
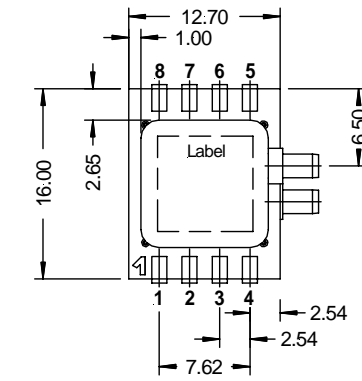
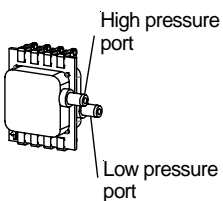
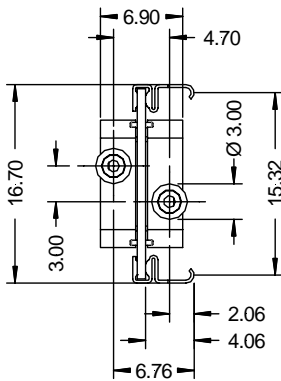

Pin	Connection
1	+Vs
2	GND
3	Vout
4	I / C *
5	SCL
6	
7	I / C *
8	SDA

\* Internal connection.  
Do not connect  
for any reason

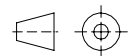

first angle projection  
dimensions in mm

# HCLA Series

## Miniature amplified low pressure sensors

### PHYSICAL DIMENSIONS AND ELECTRICAL CONNECTIONS (cont.)

HCLA...G...

SIL single port

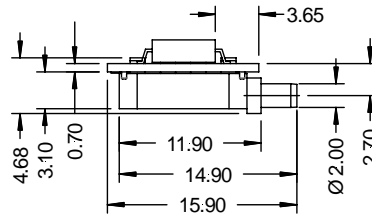
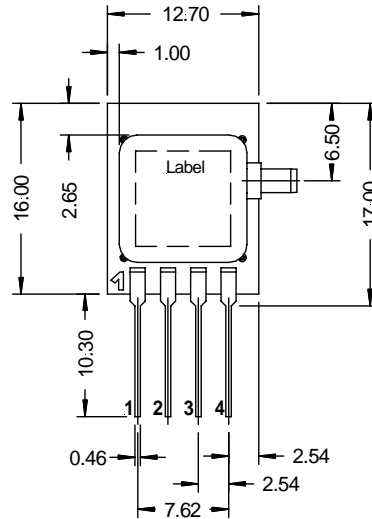
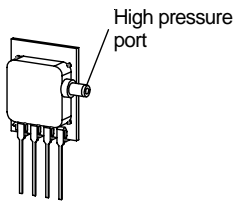
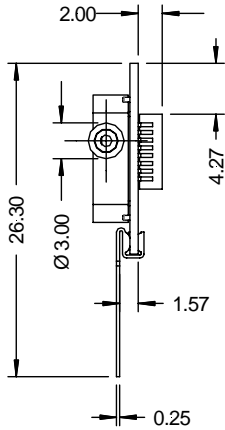

Pin	Connection
1	+Vs
2	GND
3	Vout
4	I / C *

\* Internal connection.  
Do not connect  
for any reason

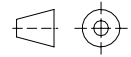

first angle projection  
dimensions in mm

HCLA...H...

SMD single port

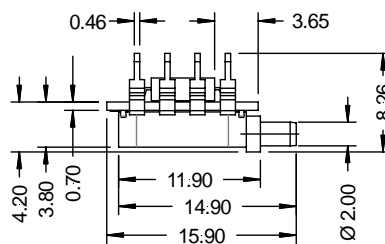
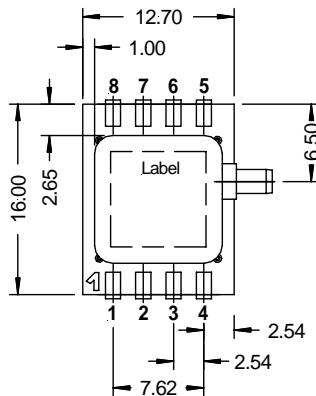
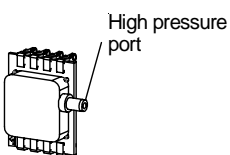
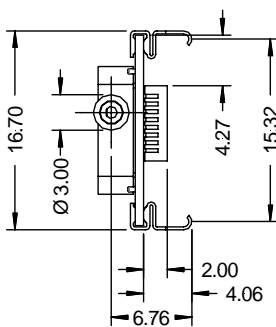

Pin	Connection
1	+Vs
2	GND
3	Vout
4	I / C *
5	SCL
6	I / C *
7	I / C *
8	SDA

\* Internal connection.  
Do not connect  
for any reason

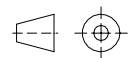

first angle projection  
dimensions in mm

# HCLA Series

## Miniature amplified low pressure sensors

### HOUSING OPTIONS

Different housing options are available on request. Please contact First Sensor.

#### SIL dual port, opposite side (HCLA...P...)

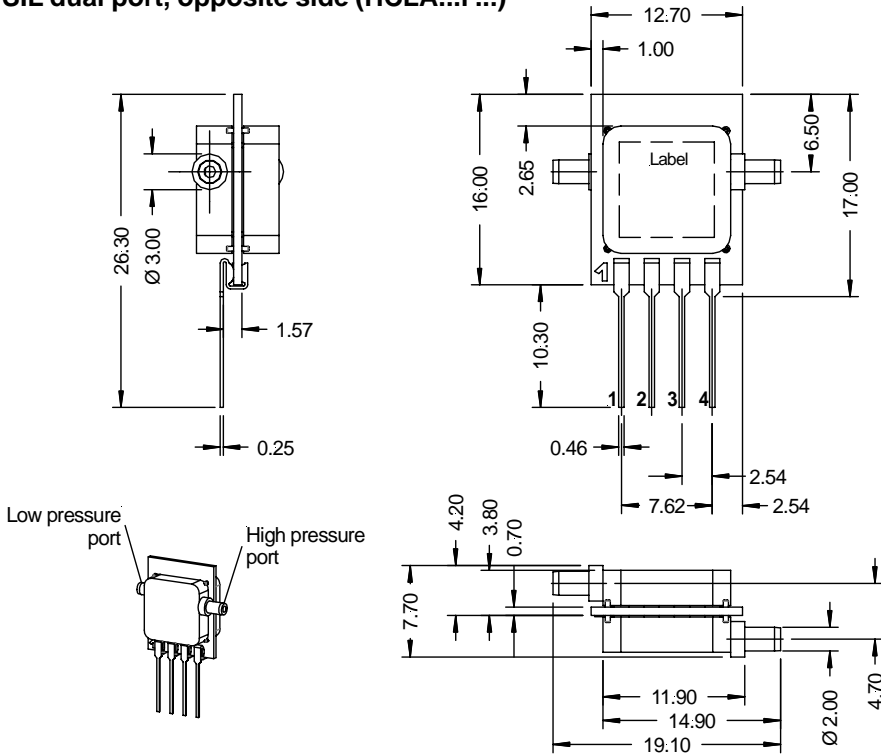

Pin	Connection
1	+Vs
2	GND
3	Vout
4	I / C *

\* Internal connection. Do not connect for any reason

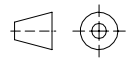

first angle projection  
dimensions in mm

#### SMD dual port, opposite side (HCLA...Q...)

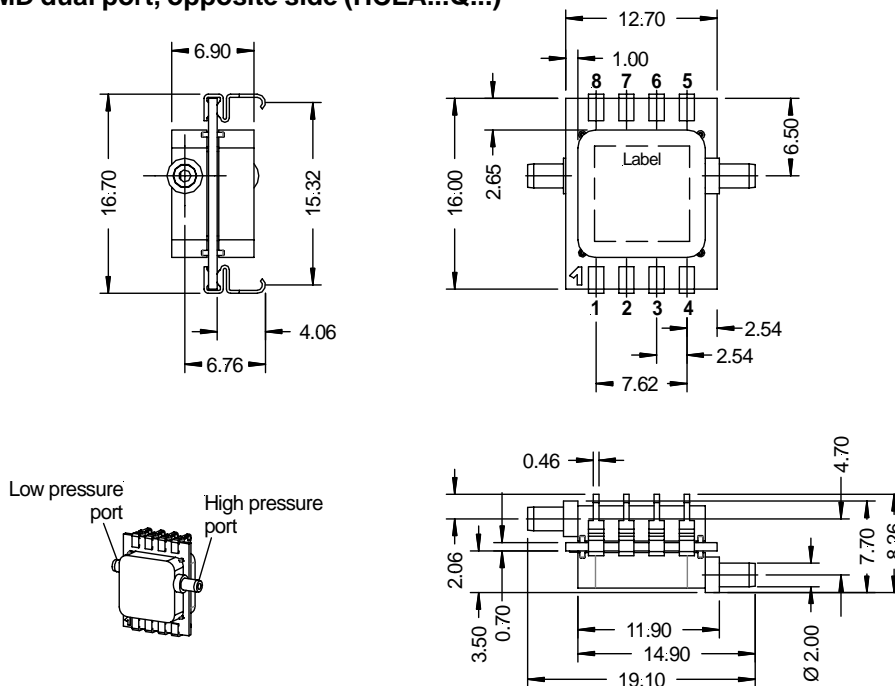

Pin	Connection
1	+Vs
2	GND
3	Vout
4	I / C *
5	SCL
6	I / C *
7	
8	SDA

\* Internal connection. Do not connect for any reason

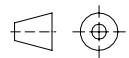

first angle projection  
dimensions in mm

# HCLA Series

## Miniature amplified low pressure sensors

### HOUSING OPTIONS (cont.)

Different housing options are available on request. Please contact First Sensor.

#### SIL dual port, top side (HCLA...T...)

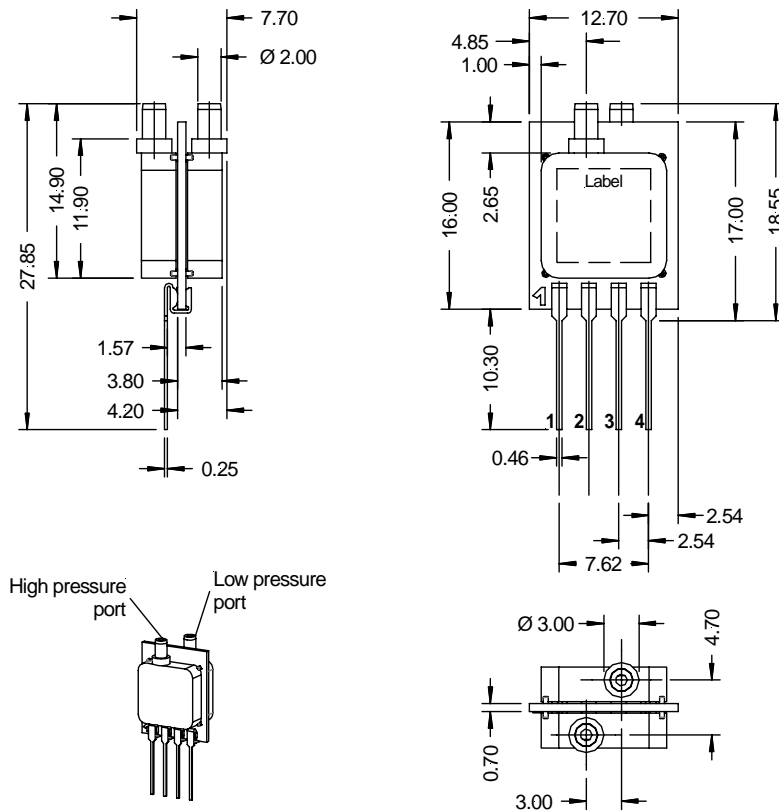

Pin	Connection
1	+Vs
2	GND
3	Vout
4	I / C *

\* Internal connection.  
Do not connect  
for any reason

first angle projection  
dimensions in mm

# HCLA Series

## Miniature amplified low pressure sensors

### HOUSING OPTIONS (cont.)

Different housing options are available on request. Please contact First Sensor.

#### Barbed pressure ports

(Available for all housing styles. Sample package shown: SMD dual port, same side)

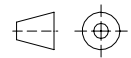
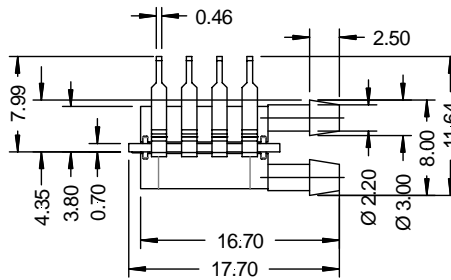
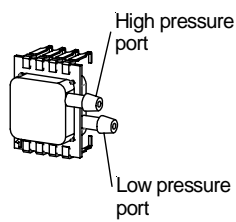
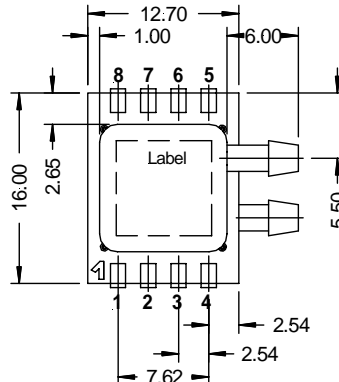
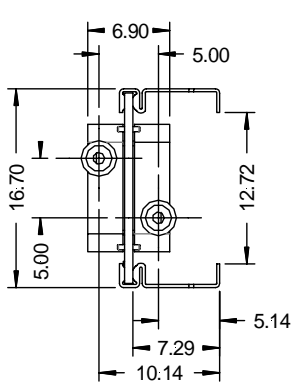

first angle projection

dimensions in mm

#### Dual Inline Packages (DIP)

(Available for all housing styles. Sample package shown: DIP dual port, same side)

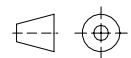
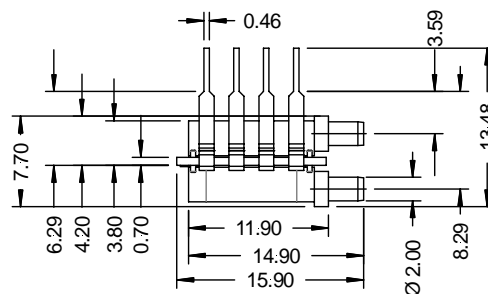
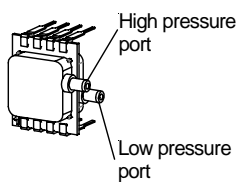
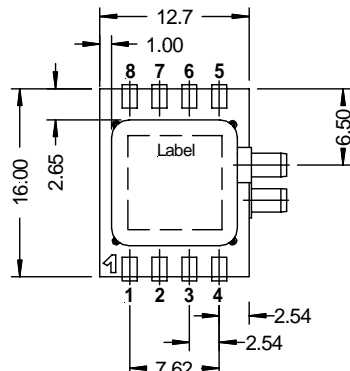
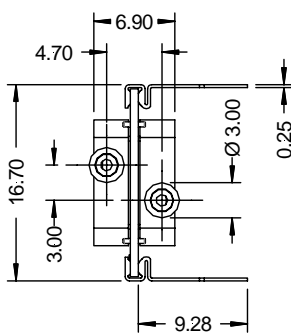

first angle projection

dimensions in mm

# HCLA Series

## Miniature amplified low pressure sensors

---

### ORDERING INFORMATION

Options	Series	Pressure range		Housing		Calibration	
		HCLA	02X5	2.5 mbar	D*	Diff SIL same side	B
		12X5	12.5 mbar	E	Diff SMD same side	U	Unidirectional
		0025	25 mbar	G*	Gage SIL		
		0050	50 mbar	H	Gage SMD		
		0075	75 mbar	(P)*	Diff SIL opposite side		
				(Q)	Diff SMD opposite side		
				(T)*	Diff SIL same top side		
				Housings P, Q, T available on request. Please contact First Sensor. * not available with digital output			
<b>Example:</b>	HCLA	02X5		E		B	

**Note: Not all possible sensor configurations are active products. MOQ may apply.**

**Custom specific pressure ranges and mechanical or electronic sensor modifications are widely available. Please contact First Sensor for further information.**

Sold in North America by:  
 Servoflo Corporation  
 75 Allen Street Lexington, MA 02421  
 Tel: 781-862-9572  
[www.servoflo.com](http://www.servoflo.com) / [info@servoflo.com](mailto:info@servoflo.com)

First Sensor reserves the right to make changes to any products herein. First Sensor does not assume any liability arising out of the application or use of any product or circuit described herein, neither does it convey any license under its patent rights nor the rights of others.