



FSP2000 User Manual VA.1

MEMS dual pressure sensors

Sold in North America by:
Servoflo Corporation
75 Allen Street
Lexington, MA 02472
www.servoflo.com/info@servoflo.com
781-862-9572

©2021 Siargo Ltd.

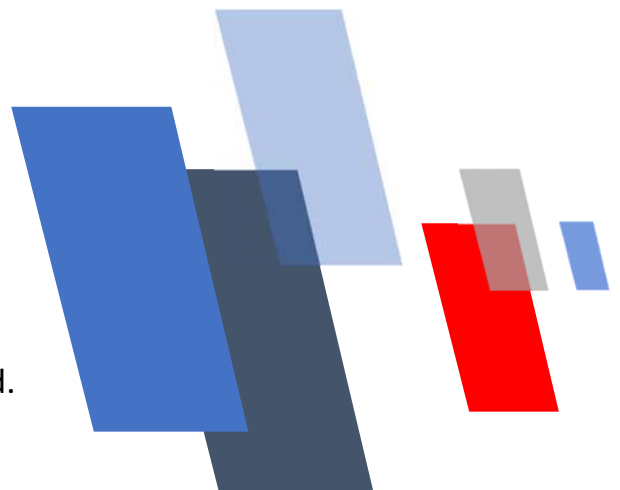

MEMS Dual Pressure Sensors

with thermal and piezo sensing technology

FSP2000 Series

User Manual

Document No. 07-2021-FP2 EN
Issue date: 2021.07
Revision: VA.1

Siargo Ltd.

3100 De La Cruz Boulevard, Suite 210
Santa Clara, California 95054
USA

Tel: +1(408)969.0368
Email: info@siargo.com

© Copyright 2021 and Liability Disclaimer

Siargo Ltd. and its subsidiaries reserve the right to change the specifications and/or descriptions without prior notice. Siargo and its subsidiaries shall not assume any inaccuracy or errors in this manual. For further information and updates, please visit www.Siargo.com.

Attention !

- Please carefully read this manual prior to operating this product.
- Do not open or modify any hardware which may lead to irrecoverable damage.
- Do not use this product if you suspect any malfunctions or deflection.
- Do not use this product for corrosive media or in a strong vibration environment.
- Use this product according to the specified parameters.
- Only the trained or qualified personnel shall be allowed to perform product services.

Use with caution !

- Be cautious for electrical safety, and even it operates at a low voltage, any electrical shock might lead to some unexpected damages.
- The gas to be measured should be clean and free of particles, as even light particles may be accumulated inside the tiny pressure port that may result in inaccuracy in metrology, clogging, or other irrecoverable damage.
- Do not apply for any unknown or non-specified gases that may damage the product.

Table of Contents

1. Overview	5
2. Receipt / unpack of the products	6
3. Knowing the products	7
3.1 Product description	7
3.2 Power and data pinout description	7
3.3 Mechanical dimensions.....	8
4. Installation	8
5. Basic operation	9
5.1 I ² C interface connection diagram	9
5.2 I ² C interface read/write sequences	9
5.3 I ² C interface command description	10
5.4 CRC checksum calculation.....	10
6. Product selection and order information	11
6.1 Product selection	11
6.2 Order contact and customer support.....	11
7. Technical specifications	12
8. Technical notes for the product performance	13
8.1 Measurement principle	13
8.2 Precautions for the best performance of the product.....	13
8.2.1 Particle contamination	13
8.2.2 Altitude changes.....	13
8.2.3 Excessive humidity or condensation.....	13
9. Warranty and Liability	14
10. Service contact and information	16
Appendix I: Sensor evaluation kit	17
Appendix II: Document history	18

1. Overview

All contact information can be found at the end of this manual.

This manual provides essential information for the FSP2000 series of dual pressure sensors for various applications. The product performance, maintenance, and troubleshooting, as well as the information for product order, technical support, and repair, are also included.

The FSP2000 dual pressure sensors are manufactured with the company's proprietary MEMS (micro-electro-mechanical systems) sensing and package technology that offers a unique combination of the differential pressure and gauge pressure capability.

The designed combination of the differential and gauge pressure sensing capability in a small footprint is for the sensing and control in a CPAP (continuous positive airway pressure) equipment that is trending for the miniaturization, where the differential pressure sensing is used for the flow measurement while the gauge pressure provides the necessary feedback for the system. This package allows the CPAP maker to save the space and cost for the required sensing data.

While the current packages are best for medical and consumer applications, the manufacturer also offers alternative customized packages. Please contact the manufacturer for additional information.

2. Receipt / unpack of the products

Upon receipt of the products, please check the packing box before the dismantlement of the packing materials. Ensure no damages during shipping. If any abnormality is observed, please contact and notify the carrier who shipped the product and inform the distributors or sales representatives if the order is not placed directly with the manufacturer; otherwise, the manufacturer should be informed. For any further actions, please refer to the return and repair section in this manual.

If the packing box is intact, proceed to open the packing box, and you shall find the product (either the sensor formality per the actual order), together with the power and data cable if the order is included as shown below.

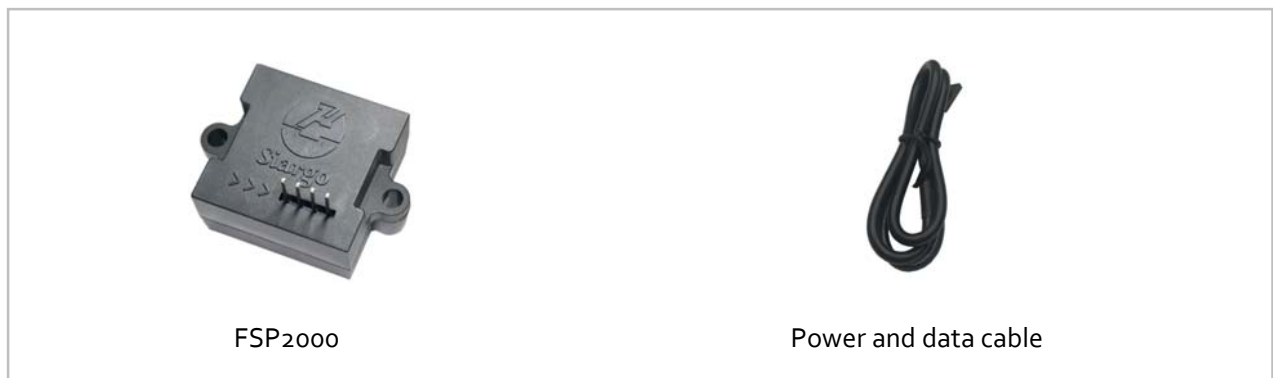

Please check immediately for the integrity of the product and the power and data cable; if any abnormality is identified, please notify the distributor/sales representative or manufacturer as soon as you can. If any defects are confirmed, an exchange shall be arranged immediately via the original sales channel. This user manual shall also be included in the packing box or via an online link for an electronic version which should be sent by your sales agent. In most cases, this manual shall be made available to the customer before the actual order.

Please note that the sensor has a pinout that is designed to be directly placed onto a printed circuitry board. Therefore, the power and data cable is an option that will not come with the order automatically.

3. Knowing the products

3.1 Product description

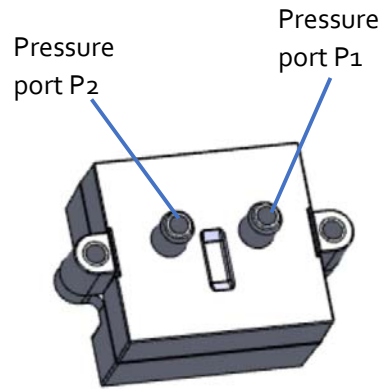
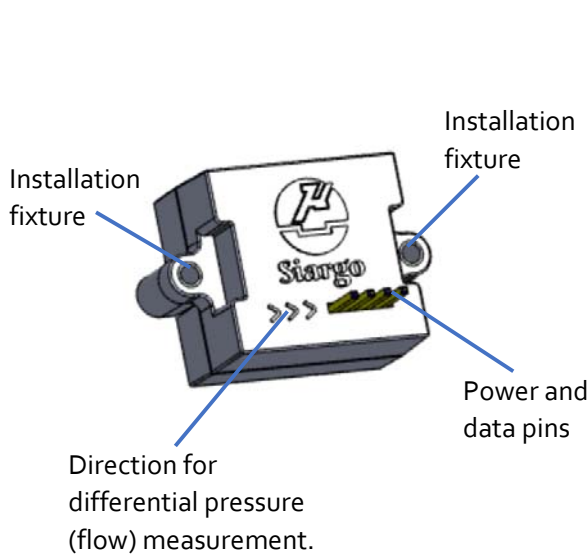

⚠ Note: for differential pressure (flow) measurement, Port P1 should be placed upstream, unless a bi-directional model is ordered.

3.2 Power and data pinout description

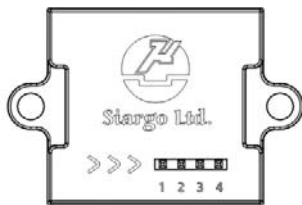

Table 3.2: FSP6000 pin assignment.

PIN	DEFINITION
1	SDA, I ² C data
2	GND, ground
3	VCC, power supply (3.0~5.5 Vdc)
4	SCL, I ² C clock

FSP2000 electrical interface has 4 pins providing I²C digital data with a 3.0~5.5 Vdc power supply. The pins can be directly soldered onto a control printed circuitry board (PCB) or via a data cable, which can be ordered from the manufacturer or made by the user.

The sensor runs with a minimal current source of 10 mA. A slightly higher current will ensure the proper operation.

3.3 Mechanical dimensions

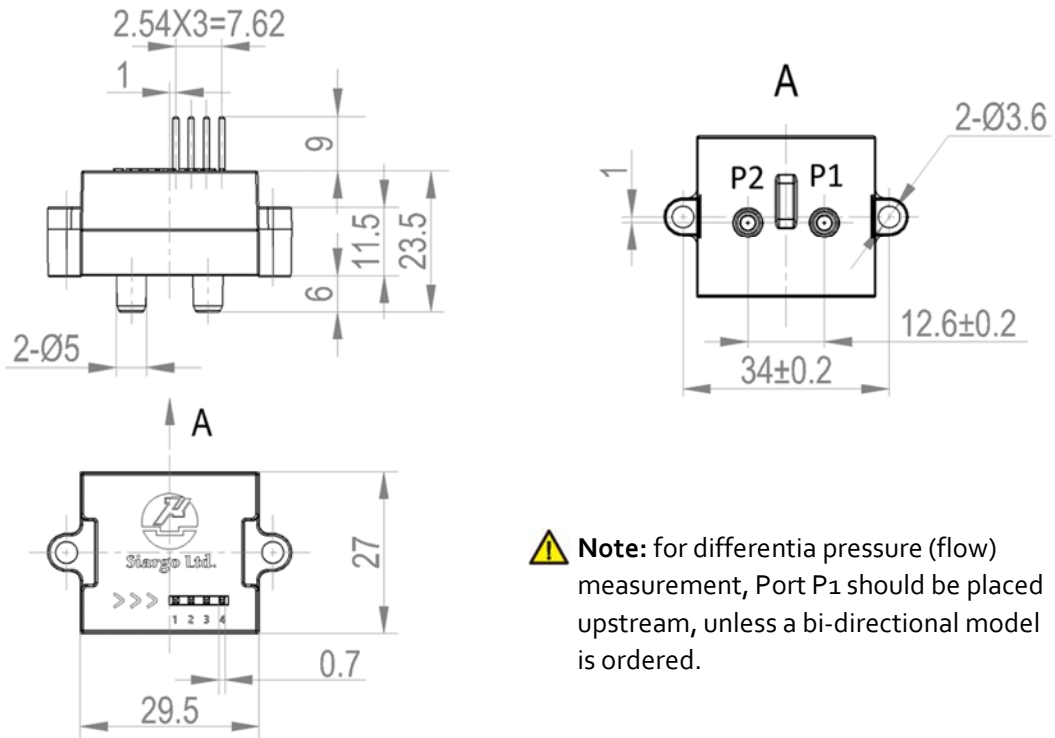

⚠ Note: for differential pressure (flow) measurement, Port P1 should be placed upstream, unless a bi-directional model is ordered.

Figure 3.3.1. FSP2000 mechanical dimensions.

4. Installation

Do not open or alter any part of the product, which would lead to malfunction and irrecoverable damage.

There are no other special requirements for the installation. But it is recommended that the user should make sure no leakage of the connections and all electrical pins are properly engaged.

5. Basic operation

5.1 I²C interface connection diagram

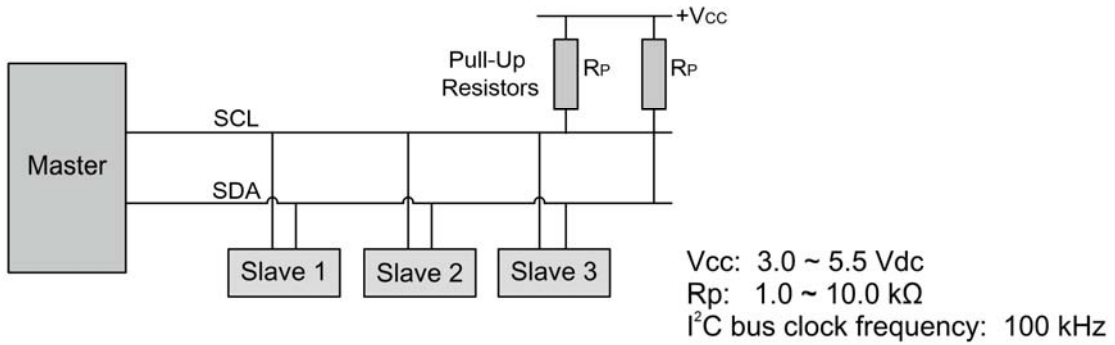

5.2 I²C interface read/write sequences

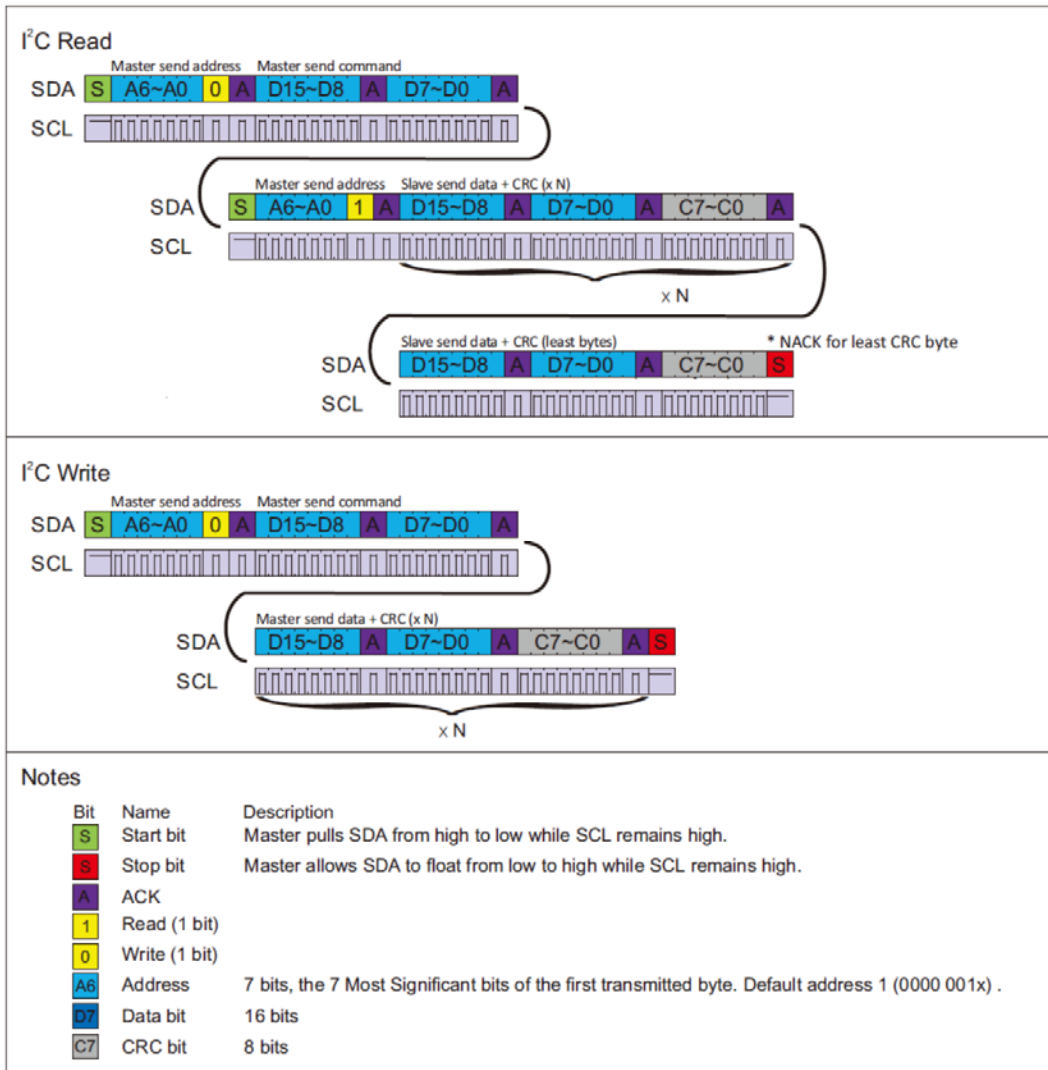

5.3 I²C interface command description

Command Byte	Length (int 16)	Command Name	Read/Write	Notes
0x00A4	1	I ² C address	Read/Write	Int 16. bit 15 ~ bit 8 = 0; bit 7 ~ bit 1 are available; bit 0 is R/W flag bit.
0x0030	6	Sensor serial number	Read	ASCII
0x0043	2	Differential pressure	Read	Int 32/1000 Pa
0x0045	2	Gauge pressure	Read	Int 32/1000 cmH ₂ O
0x00F0	1	Reset the offset of differential pressure	Write	Fixed value, 0xAA55
0x00F1	1	Reset the offset of gauge pressure	Write	Fixed value, 0xAA55

Note: The I²C address is set to bit 7 ~ bit 1. E.g. if the I²C address is 1 (0000 001x), the write address will be 0x02 (0000 0010) and the read address will be 0x03 (0000 0011).

5.4 CRC checksum calculation

The 8-bit CRC checksum transmitted after each two data bytes (int 16) is generated by a CRC algorithm. Its properties are listed in the table below. To calculate the checksum, only these two previously transmitted data bytes are used.

Property	Value
Name	CRC-8
Protected data	I ² C read and write
Width	8 bits
Polynomial	0x07 ($x^8 + x^2 + x + 1$)
Initialization	0x00
Reflect input	False
Reflect output	False
Final XOR	0x00
Example	CRC(0x4E20) = 0x6D

6. Product selection and order information

6.1 Product selection

The product part number is composed of the product model number and suffixes, indicating each of the selectable parameters. Refer to the following for details.

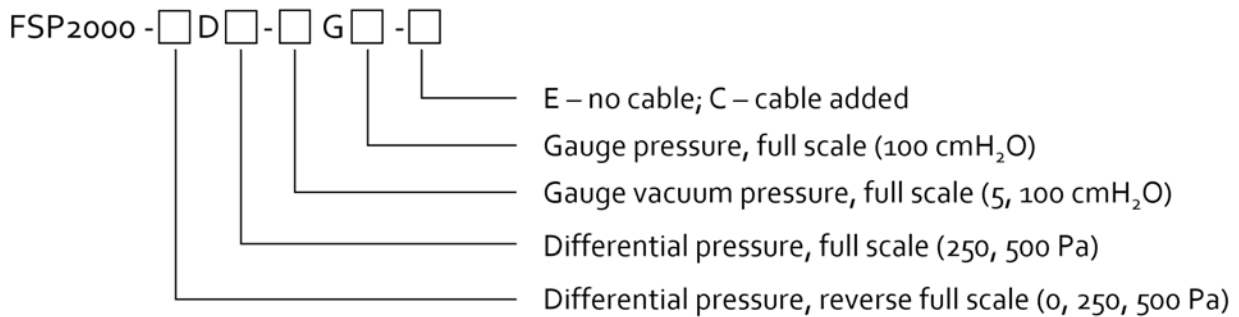

Note:

1. Example: FSP2000-500D-500-5G100-E: the differential pressure range will be ± 500 Pa, and gauge pressure range -5 to 100 cmH₂O.
2. Gauge pressure full scale at the current offer is 100 cmH₂O, reserved for future upgrade.

6.2 Order contact and customer support

The sales offices and the sales distributors/representatives are listed at the end of this document. For small quantities, the order can be placed either through the Siargo website: www.siargo.com or the sales office. For large quantities, please contact the sales office, distributors, or sales representatives.

Siargo is making every effort to ensure the quality of the products. In case of questions and/or product supports, please contact the customer service listed at the end of the document.

7. Technical specifications

All specifications listed in the following table, unless otherwise noted, apply for calibration conditions at 20°C and 101.325 kPa absolute pressure with air.

	Value	Unit
Differential pressure	250 / 500 / ±250 / ±500	Pa
Gauge pressure	-5-100 / ±100	cmH ₂ O
Accuracy, differential pressure*	±(2.0+0.5FS)	%
Accuracy, gauge pressure	±1.0FS	%
Response time	1.8	msec
Repeatability	±0.5	%
Span temperature coefficient	<±0.12	%/°C
Compensated temperate range	-5 ~ +65	°C
Pressure rating	50	kPa
Altitude correction	Fully compensated	
Warm-up time (max)	10	sec
Humidity	0~100 (no condensation)	%RH
Power supply, voltage	3.0~5.5	Vdc
Power supply, minimal current	10	mA
Pneumatic flow resistance	<95	sccm@500Pa
Output	Linear, I ² C	
Storage temperature	-20~70	°C
Vibration	20g; MIL-STD-883E, Method 2002.4.	
Compliance	RoHS; REACH	

Note: *FS = full scale at one direction. Customized differential pressure range is available upon request.

$$1 \text{ cmH}_2\text{O} (4 \text{ }^\circ\text{C}) = 98.06 \text{ Pa} = 0.014 \text{ PSI}$$

8. Technical notes for the product performance

8.1 Measurement principle

The products utilize the Company's proprietary micro-machined (MEMS) sensing technology. The gauge pressure is realized via the piezoresistive sensing, while the differential pressure is via a pass-through flow sensing at two ports where the flow channel defines the differential pressure from the channel design.

8.2 Precautions for the best performance of the product

8.2.1 Particle contamination

It is critical to have the measured gas free of particle contamination. Since the data ports for both the gauge pressure and differential pressure is small, any particle's presence may create a deformed channel leading to large measurement errors. The particle deposition may also clog the channel, creating unstable data output and other instability, resulting in unpredictable measurement circumstances.

8.2.2 Altitude changes

Unlike some other products on market, the design of the sensor has a built-in pressure balancer that preventing membrane deformation due to altitude changes. Therefore, the sensor is intrinsically insensitive to the altitude change-induced errors.

8.2.3 Excessive humidity or condensation

The humidity change will not alter the performance of the sensor. However, if excessive humidity is present resulting in condensation, the measurement port or channel could be blocked or altered. This would result in a very unreliable data output. Please filter or other tools to prevent this situation to occur when using this product.

9. Warranty and Liability

(Effective January 2018)

Siargo warrants the products sold hereunder, properly used, and properly installed under normal circumstances and service. As described in this user manual, it shall be free from faulty materials or workmanship for 180 days for OEM products and 365 days for non-OEM products from the date of shipment. This warranty period is inclusive of any statutory warranty. Any repair or replacement serviced product shall bear the same terms in this warranty.

Siargo makes no warranty, representation, or guarantee and shall not assume any liability regarding the suitability of the products described in this manual for any purposes that are not specified in this manual. The users shall be held for full responsibility for validating the performance and suitability of the products for their particular design and applications. For any of the misuse of the products out of the scope described herein, the user shall indemnify and hold Siargo and its officers, employees, subsidiaries, affiliates, and sales channels harmless against all claims, costs, damages, and expense or reasonable attorney fee from direct or indirect sources.

Siargo makes no other warranty, express or implied, and assumes no liability for any special or incidental damage or charges, including but not limited to any damages or charges due to installation, dismantling, reinstallation, etc. other consequential or indirect damages of any kind. To the extent permitted by law, the exclusive remedy of the user or purchaser, and the limit of Siargo's liability for any and all losses, injuries, or damages concerning the products, including claims based on contract, negligence, tort, strict liability, or otherwise shall be the return of products to Siargo, and upon verification of Siargo to prove to be defective, at its sole option, to refund, repair or replacement of the products. Regardless of form, no action may be brought against Siargo more than 365 days after a cause of action has accrued. The products returned under warranty to Siargo shall be at the user or purchaser's risk of loss and will be returned, if at all, at Siargo's risk of loss. Purchasers or users are deemed to have accepted this limitation of warranty and liability, which contains the complete and exclusive limited warranty of Siargo. It shall not be amended, modified, or its terms waived except by Siargo's sole action.

This manual's product information is believed to be accurate and reliable at the time of release to or made available to the users. However, Siargo shall assume no responsibility for any inaccuracies and/or errors and reserves the right to make changes without further notice for the relevant information herein.

This warranty is subject to the following exclusions:

- (1) Products that have been altered, modified, or have been subject to unusual physical or electrical circumstances indicated but not limited to those stated in this document or any other actions which cannot be deemed as proper use of the products;

- (2) Products that have been subject to chemical attacks, including exposure to corrosive substances or contaminants. In the case of battery usage, long term discharge or leakage induced damages;
- (3) Products that have been opened or dismantled for whatever reasons;
- (4) Products that have been subject to working conditions beyond the technical specification as described by this manual or related datasheet published by the manufacturer;
- (5) Any damages incurred by the incorrect usage of the products;
- (6) Siargo does not provide any warranty on finished goods manufactured by others. Only the original manufacturer's warranty applies;
- (7) Products that are re-sold by unauthorized dealers or any third parties.

10. Service contact and information

Siargo Ltd. is making every effort to ensure the quality of the products. In case of questions and or product supports, please contact customer service at the address listed below. We will respond to your request in a timely fashion and work with you toward your complete satisfaction.

Customer service and all orders should be addressed to

Siargo Ltd.
3100 De La Cruz Boulevard, Suite 210,
Santa Clara, California 95054, USA
Phone: +01(408)969-0368
Email: info@Siargo.com

For orders, please provide an accurate and full postal address. Siargo will not ship to P.O. Boxes or via a third party.

Please contact info@siargo.com to obtain a Return Materials Authorization (RMA) before shipping the product back to the factory for returns or factory services such as calibration. Please specify as clear and detailed as possible in your email message the product's status that you intend to ship back to the factory. Be sure to write the RMA on the returned package or include a letter with the RMA information.

For further information and updates, please visit www.Siargo.com.

Appendix I: Sensor evaluation kit

Siargo offers a sensor evaluation kit, including a digital data converter, USB data cable, and a User Application software, that allows the user to evaluate the product performance on a Microsoft Windows-based computer. The user can read and visualize the flow rate of the product, obtain the totalized values, and save the data for further analysis. It can read from up to 128 sensors with the I²C interface in serial.

For further information and purchase of the evaluation kit, please contact the manufacturer or the sales representative.

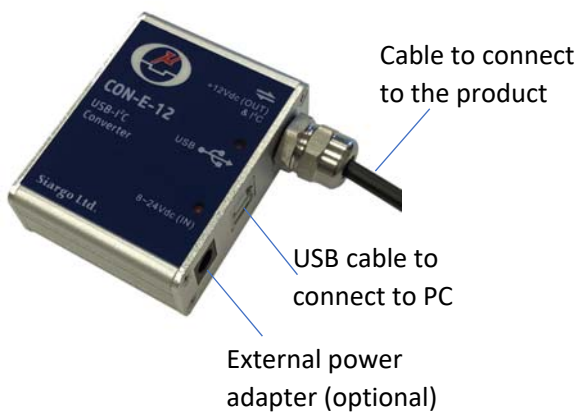

Each converter has a fixed cable that can be directly connected to the product. The USB cable connected to the PC is also included.

For most of the product, the power from the PC via the USB cable will be sufficient to power the sensor product, no external power will be required. However, for multiple sensors in serial, the power via the USB cable may not be enough, an external power adapter with 8~24Vdc will be required.

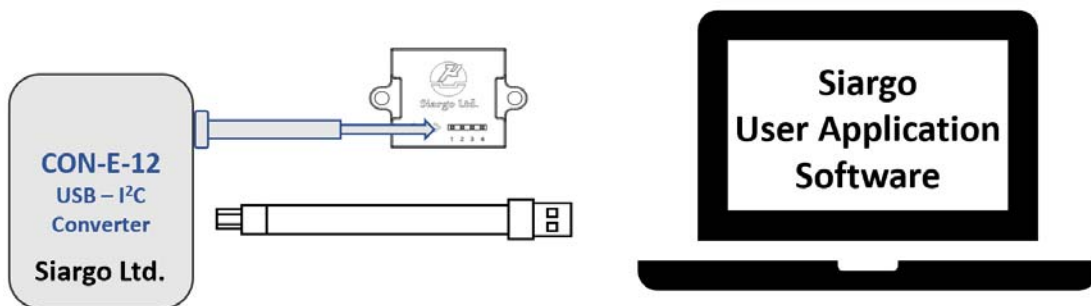

Appendix II: Document history

07.2021	VA.1 – Reformated and I ² C communication update.
02.2021	VA.0 - First release